

**COLLINS
BROADCAST
EQUIPMENT**

To Our Customers:

This, our first new catalog in several years, manifests Collins' renewed dedication to the Broadcast industry. The new transmitters and consoles introduced in these pages are the first fruits of a new product development program, from which you will be seeing even more results in the months ahead.

Historically, Collins has been noted for its marked conservatism in stating equipment specifications -- and we continue to be. Even so, I want to personally emphasize that all Collins published specifications are guaranteed in writing to be met under normal installation conditions.

Our users know that Collins Broadcast equipment is priced competitively and is designed to give you the best sound on the air.

Very truly yours,

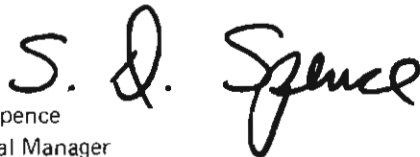
A handwritten signature in black ink that reads "S. D. Spence". The signature is written in a cursive style with a large, stylized "S" and "D".

S.D. Spence
General Manager
Broadcast Division
Collins Radio Company

Filament and plate controls are separate pushbuttons on the front panel, with a built-in 120-second delay between filament and plate initiation to allow for tube warmup. Overload sensors are located in both the driver and final sections of the amplifiers, as well as in the transmission line to detect abnormally high vswr. After tripping, the recycle circuit will attempt to start the transmitter again, either two or four times in a 30-second time period after failure. If, after that time, the overload condition still exists, the transmitter will remain off, and indicator lamps will show where the malfunction exists.

The reliability of the Collins 831H-1/1B is enhanced by the use of solid state components with the exception of the

driver and final amplifier tubes. A neutralized power amplifier improves stability, and minimizes tuning and loading adjustment problems.

The entire transmitter is contained in two cabinets, the only external components being those associated with the combiner and optional automatic switching gear. The Collins 831H-1/1B Transmitters provide the broadcaster with a truly redundant system that offers the flexibility that enables full time operation with a minimum of "down time." This, coupled with Collins 24-hour field service operation, and unparalleled warranty, give more value per dollar than any competitive system on the market.

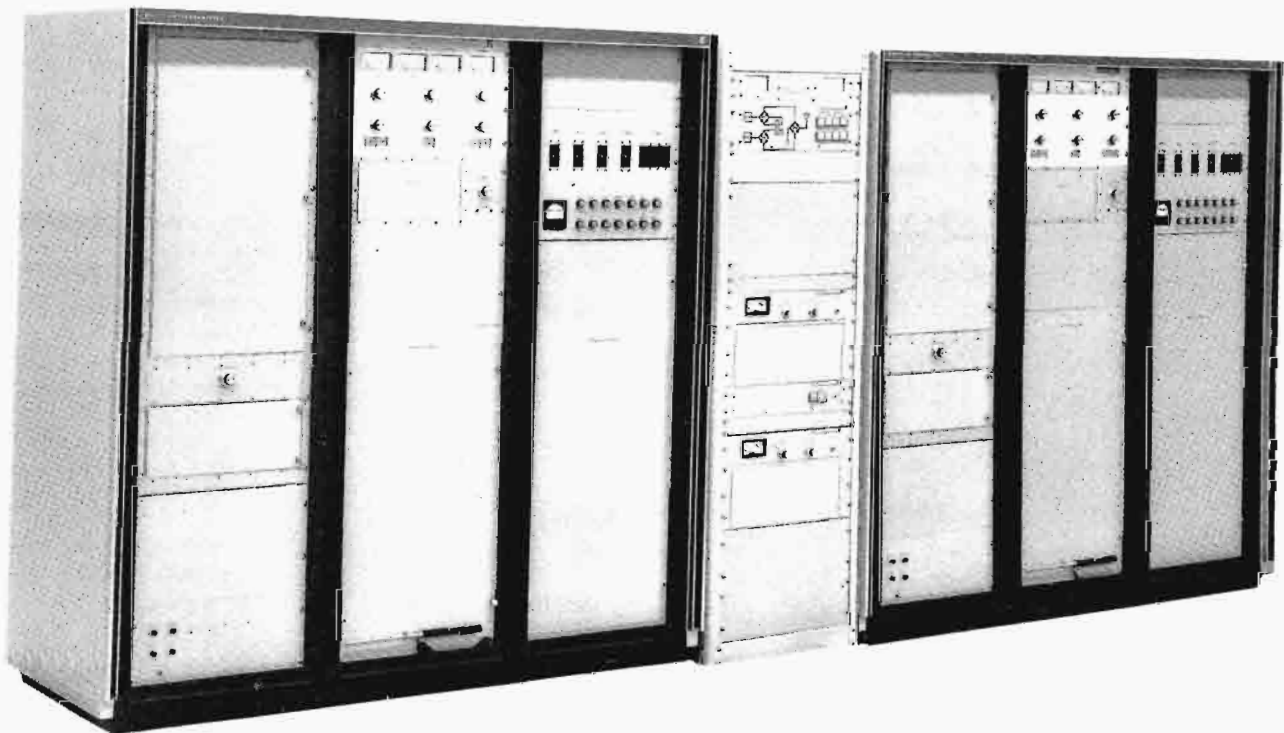

831H FM Transmitter

As an option, an automatic switching system consisting of the 377C-1 Exciter Control, and the 377D-1 Combiner Control, is available to facilitate a completely redundant operation. These units monitor all parameters of operation, and make decisions as to what exciter/transmitter/antenna combination will give best service in the event of equipment failure. A complete description of the system options follows this section.

Before our transmitters are shipped to a customer, they are set up on the exact frequency that will be used in operation, and tested at full rated power for extended periods of time, in a lab that provides every conceivable operating condition. After it has been determined that the unit satisfies every stringent Collins standard, it is packaged and shipped to the installation site, complete with all test data, and instructions for installation.

CONFIGURATION MATRIX

CONFIG NO.	831G-1 (LESS 3102-1)	3102-1	377C-1 AUTO EXC CONTROL	377D-1 AUTO COMBINER CONTROL	POWER MONITOR PANEL	DIPLEXER AND COAX ELEMENTS	20 KW REJECT SWITCHES & COAX ELEMENTS	MANUAL EXCITER SWITCH PANEL	50 KW DUMMY LOAD
1	2	1		1	1	1			
2	2	2		1	1	1	1		
3	2	2	1	1	1	1			
4	2	2	1	1	1	1	1	1	

- NO. 1 - BASIC MANUAL SYSTEM (NO SWITCHING) - ONE EXCITER.
- NO. 2 - BASIC MANUAL SYSTEM (NO SWITCHING) - DUAL EXCITERS.
- NO. 3 - BASIC MANUAL SYSTEM (NO SWITCHING IN OUTPUT) - DUAL AUTOMATIC EXCITERS.
- NO. 4 - FULL DUAL AUTOMATIC SYSTEM.

831H Series specifications

- Output Power 831H-1B: 45 kW
831H-1: 40 kW
- Output Impedance 50 ohms, vswr 2:1 maximum
- Frequency Range 88 to 108 MHz
- Frequency Stability ±1000 Hz
- Modulation Capability ±100 KHz
- Audio Input Level 10 dBm ±2 dB
- Audio Frequency Response Complies with FCC standard preemphasis curve
- Audio Frequency Distortion Monaural: production test spec is 1% (typical is 0.5% or less) 50 to 15000 Hz

- Harmonic Attenuation 80 dB minimum
- FM Noise Level 65 dB below 100% modulation (±75 KHz)
- AM Noise Level 55 dB rms
- Altitude Operating 7500 ft at 30°C
Non-operating 10,000 ft
- Power Source 200 to 250 volts ac 50/60 Hz 3 phase. Available taps on transformers are for 200, 210, 220, 230, 240 and 250 volts

- Permissible Line Voltage Variation ±5%. In addition, each phase voltage shall be within 5% of the average of all three phases
- Power Requirements Nominal 40 kW output requires 70 kVA at 0.97 power factor; nominal 45 kW output requires 78 kVA at 0.97 power factor
- Size 68-15/16" (175.1 cm) H; 143" (363.2 cm) W, plus 22" (55.8 cm) cabinet for control and switching panels; 29" (73.6 cm) D.
- Weight From 4800 lbs (2090 kg) to 5500 lbs (2495 kg) depending on configuration.

- 831H-1 FM Transmitter, 40 kW
- 831H-1B FM Transmitter, 45 kW

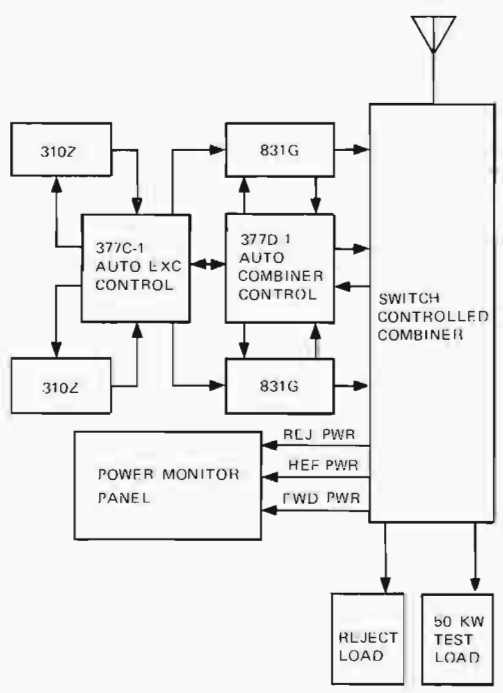

831H Block Diagram

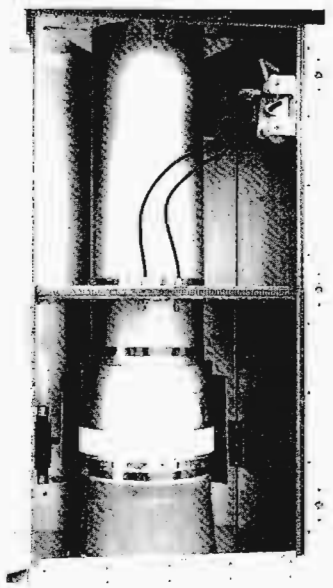

831H Cavity

Automatic Transmitter Switching Equipment

Broadcasters using the 831H FM transmitters can realize the optimum in reliability and ease of maintenance through addition of the optional automatic switching and control equipment. This provides switching to a hot standby exciter in the dual configuration, or the complete isolation of a power amplifier in the case of failure or routine maintenance. These switching units are completely solid state utilizing integrated circuits to perform the necessary logic, and led's (light emitting diodes) for condition indicators. In addition to providing local control, the units may be remoted for convenience. The combination of logic circuits and motor-driven coax switches gives complete and accurate switching in the matter of seconds instead of minutes as required for manual operation. A complete interlock prevents inadvertent operation of the amplifiers into a no-load condition.

377C-1

The Collins 377C-1 Automatic Exciter Switcher provides monitoring and control for two 310Z Exciters or similar units. If one unit fails, the 377C-1 automatically transfers the standby unit on the line.

While in the hot standby mode, an exciter is maintained at 5-10% of normal power, thus conserving both power and equipment. When the unit is switched on the air, it comes to full power in less than 100 milliseconds. In addition, an indicator flashes to show which exciter is defective, eliminating the possibility of turning off the wrong unit for servicing. Included in the 377C-1 are facilities to switch station monitors to the dummy load for servicing of the exciter that is not on the air.

377D-1

The Collins 377D-1 Automatic Combiner Control provides automatic or manual control of two power amplifiers and a three-switch combiner for parallel transmitter operation. The 377D-1 automatically assures maximum available power to the antenna at all times. If a failure occurs in either power amplifier, the remaining amplifier is switched to the antenna, while the defective one is switched to the dummy load. The 377D-1 provides all interlock functions for two amplifiers to assure proper sequencing and powering up.

The 377D-1 is completely solid state, with integrated circuits being utilized to provide the reliable digital control that this unit offers. To provide an indication of the several modes of operation that are available, a series of red and green light emitting diodes are used in the form of a flow chart on the front panel. At a glance, the engineer can tell exactly what transmitter is on the line, and what path the

RF is taking to get to the antenna. An internal ni-cad battery supply across the dc power supply, assures that in the event of total power failure, the logic circuits remember what mode of operation the system was in, thus making return to the air as simple as possible.

In actual operation, the 377D-1 monitors the outputs of two independent power amplifiers continuously, and in the event of outright failure of either amplifier, will automatically initiate a transfer command to place the other amplifier directly on the air, bypassing the combiner. Time delay between failure and automatic transfer initiation is adjustable from 1 second to several minutes. The 377D-1 may also be used to automatically switch a "hot standby" transmitter or power amplifier into service in alternate main installations.

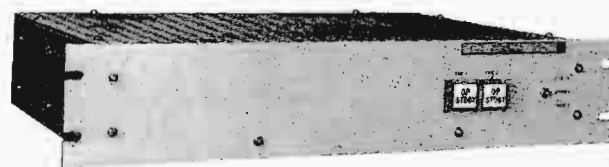

377C-1 Automatic Exciter Switchover

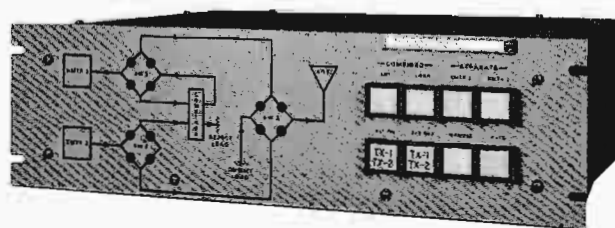

377D-1 Automatic Combiner Control

The command signal that the logic circuitry generates is routed to both the proper switching elements, and a logic comparison system. Before ac power is applied to the coaxial switches, two rf sensing gates must be opened, denoting that there is no rf present on the switches. This process is accelerated by supplying a muting pulse to the exciter in use, and by opening the power amplifier interlock circuits. When complete shutdown is confirmed by the rf gates, ac power is applied to the coaxial switches. When the switches have transferred to their assigned positions, interlock readback logic is compared to the preprogrammed logic for the selected mode and the proper amplifier or amplifiers are returned to the air. The defective power amplifier is automatically placed on the dummy load for servicing. Its interlock circuits are opened until the dummy load air or water flow interlock is closed.

831G-1/1B FM Transmitters

The 831G Transmitters are offered in two configurations. The first is a 20-kW version, and the second, an upgraded 22.5-kW unit. This transmitter line is the basic equipment used to provide the various high power transmitters that Collins offers. All of the features that are offered in the 831H line of transmitters are present in the 831G line, and in addition, the following operational advantages are of interest.

The 831G-1/1B transmitters have only three tubes—two in the driver, one in the final. The entire transmitter is contained in one three-bay cabinet that lends itself to restricted space, and ease of maintenance. A high-Q final cavity and an efficient self-contained low-pass filter provide attenuation of harmonics that is far below FCC regulations. All tuning and control functions are on the front panel, thus simplifying operation and maintenance. The control panel may be removed from the transmitter and located up to 50 feet from the unit.

As in all of the Collins FM transmitters, the 831G series uses the Collins 310Z Exciter to provide a signal that is second to none for quality and reliability. This all solid state exciter added to the proven quality of the 831G-1 or 831G-1B Power Amplifier, offers the broadcaster savings in cost of operation that is unexcelled.

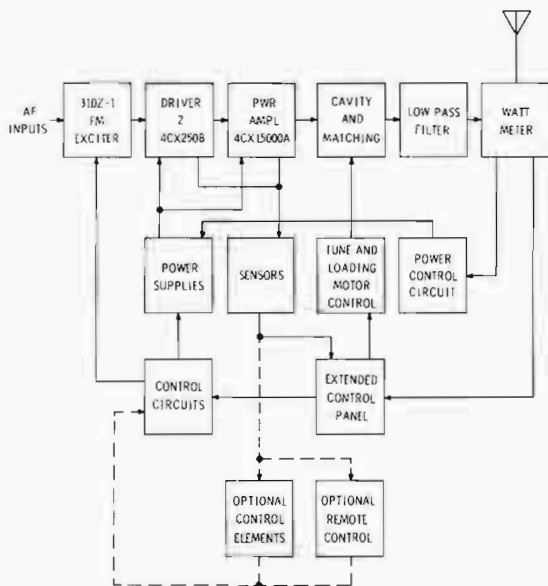

831G Block Diagram

831G Series specifications

Output Power	831G-1: 20 kW 831G-1B: 22.5 kW
Output Impedance	50 ohms, VSWR 2:1 maximum.
Frequency Range	88-108 MHz.
Frequency Stability	±1000 Hz.
Modulation Capability	±100 KHz.
Audio Input Level	10 dbm ±2 db.
Audio Frequency Response	Complies with FCC standard pre-emphasis curve.
Audio Frequency Distortion	Monaural: prod test spec is 1.0% or less (typical 0.5% or less) 50 to 15,000 Hz.
Stereo Separation	35 dB minimum, 50 to 15,000 Hz (39 dB typical)
Harmonic Attenuation	-80 db minimum.
FM Noise Level	65 db below 100% modulation (±75 kHz).
AM Noise Level	-55 db RMS.
Altitude	Operating 7500 ft. @ 30°C. Non-operating 10,000 ft.
Power Source	200-250 volts ac 50/60 Hz three-phase. Available taps on transformers are for 200, 210, 220, 230, 240, and 250 volts.
Permissible Line Voltage	±5%. In addition, each phase voltage shall be within 5% of the average of all three phases.
Power Requirements	Nominal 20 kW output requires 35 kVa at 0.97 power factor; nominal 22.5 kW output requires 39 kVa at 0.97 power factor.
Size:	68-15/16" (175.1 cm) H; 71-1/2" (181.6 cm) W; 27-1/2" (69.8 cm) D.
Weight:	2400 lbs (1045 kg).
831G-1	FM Transmitter, 20 kW
831G-1B	FM Transmitter, 22.5 kW

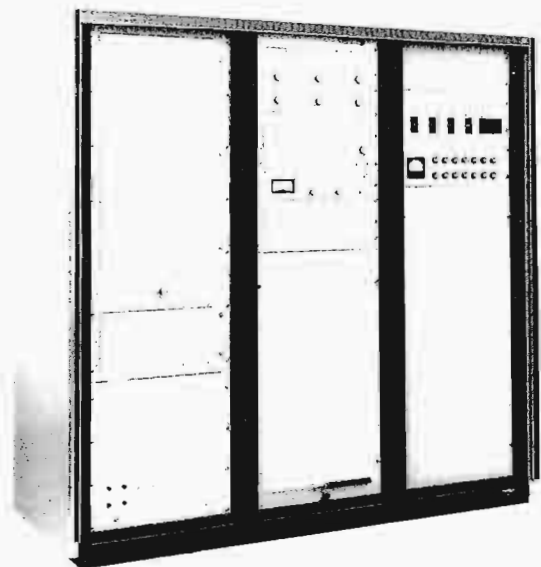

831G FM Transmitter

310Z FM Exciter

The Collins 310Z FM Exciter features the newest concepts in FM broadcast exciter design. This exciter, completely solid state, provides a frequency-modulated 88- to 108-MHz signal suitable for further amplification.

Monaural, stereophonic, and SCA audio inputs are provided to facilitate any type of operation. The 310Z is designed to match a 50Ω load, and accepts input frequencies up to 75 kHz. Plug-in circuit card construction makes the exciter compact and easily maintained. The circuit cards may be extended from the transmitter front panel for test and maintenance.

Output power may be adjusted manually at the unit, or automatically from a remote location. Accessibility and maintainability are greatly improved through total modular construction, and all circuitry and adequate test points are accessible from the front of the exciter.

For stereo, or SCA operation, the optional 786V-1 Stereo Generator or 786W-1 SCA Generator cards may be employed. Collins uses the direct FM method of modulation, superior to any other method in use.

During monaural operation, audio is applied directly to the baseband amplifier. The 14-MHz oscillator is modulated with the signal from the baseband amplifier. The result of this is a 14-MHz signal with a ±75-kHz peak deviation about the center frequency. The output of this oscillator is then mixed with another crystal-controlled oscillator that operates on a frequency that is 14 MHz below the station frequency. The resulting sum frequency is then amplified in a three-stage amplifier and provided as an output.

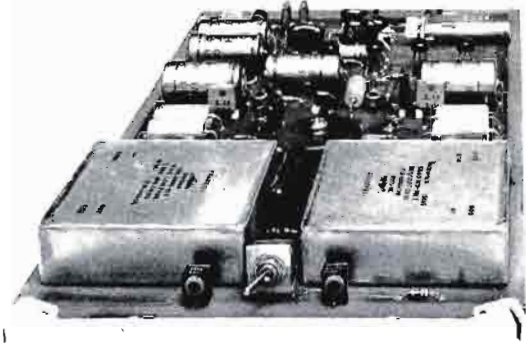

786V-1 Stereo Generator

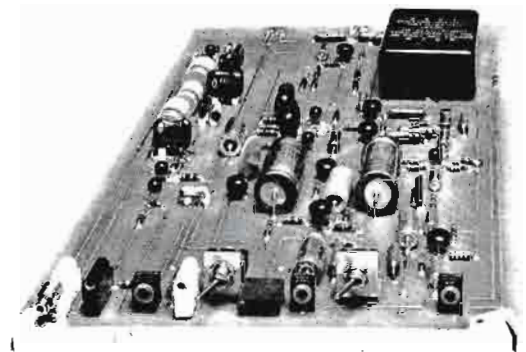

786W-1 SCA Generator



310Z FM Exciter

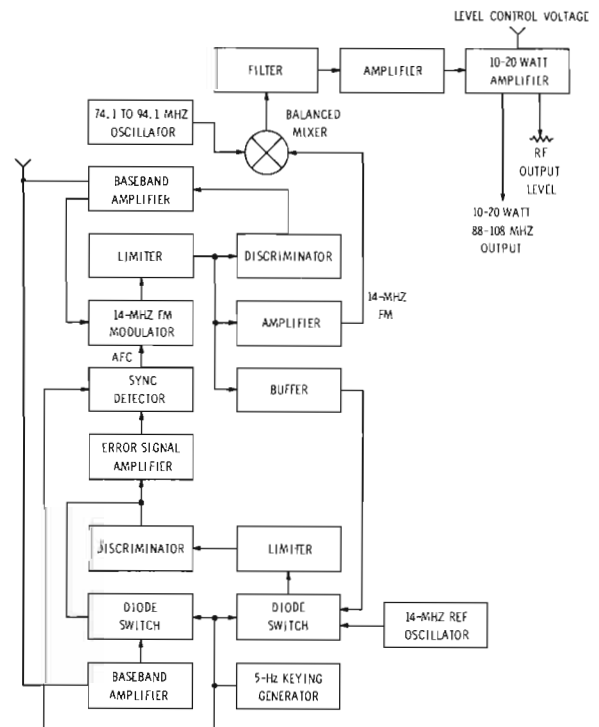

310Z Block Diagram

831F-1 FM Transmitters

The Collins 831F-1 Transmitter provides the same low cost operation that the high power 831G series does through sound design concepts and state-of-the-art components and methods. The same modular construction and vertical component placement make routine maintenance procedures simple. As in the other lines that Collins offers, the 10-kW 831F-1 FM Transmitter utilizes the Collins 310Z solid state exciter for a sound that is as clean and distortion-free as a live performance.

Automatic power output control is a standard feature, as well as automatic filament voltage regulation to within 2%. Another automatic function is the overload recycling and fault indicator system. In the event of a failure, whether it be internal or external, the automatic recycle function will attempt to put the transmitter back on the air, but after a predetermined number of tries, will cease to operate, thus protecting the transmitter system components.

The transmitter is completely assembled and tested on the customer's frequency and power level to assure rapid installation and worry-free operation over a long time span. For shipment, a few components are removed to assure shipment without damage. A complete set of test data is supplied, showing all the operating parameters of the specific transmitter received. Since the entire Collins transmitter line is designed to exceed FCC minimums, future concern about obsolescence is minimized.

The 831F-1 has only two tubes, a 4CX250B driver, and a 4CX5000A power amplifier operating at Class C. Neutralizing provides for stable operation, and ease of tuning. A completely solid state power supply assures long life and steady performance.

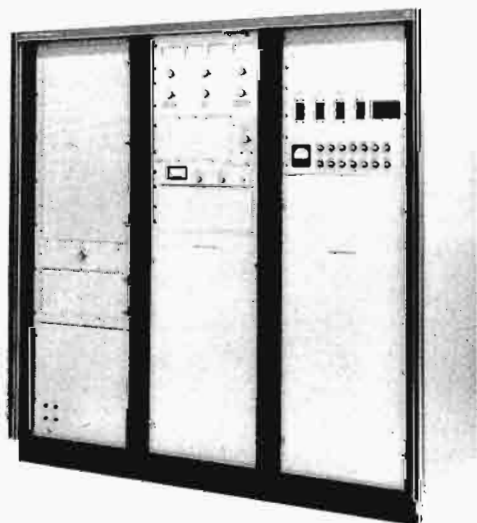

831F-1 FM Transmitter

831F-1 specifications

Output Power	10 kW
Output Impedance	50 ohms, vswr 2:1 maximum
Frequency Range	88 to 108 MHz
Frequency Stability	±1000 Hz
Modulation Capability	±100 kHz
Audio Input Level	10 dBm ±2 dB
Audio Frequency Response	Complies with FCC standard pre-emphasis curve
Audio Frequency Distortion	Monaural: PTR is NMT 1.0%. (Typical) is 0.5% or less) 50 to 15,000 Hz
Stereo Separation	35 dB minimum, 50 to 15,000 Hz (39 dB typical)
Harmonic Attenuation	-80 dB minimum
FM Noise Level	65 dB below 100% modulation (±75 kHz)
AM Noise Level	-55 dB rms
Altitude	Operating 7500 ft at 30°C Nonoperating 10,000 ft
Power Source	200 to 250 volts ac 50/60 Hz 3-phase. Available taps on transformers are for 200, 210, 220, 230, 240, and 250 volts
Permissible Line Voltage Variation	±5%. In addition, each phase voltage shall be within 5% of the average of all three phases.
Power Requirements	Nominal 10 kW output requires 21 kVA at 0.97 power factor
Size	65-15/16" (175.1 cm) H; 71-1/2" (181.6 cm) W; 27-1/2" (69.8 cm) D.
Weight	2300 lbs (1025 kg).
831F-1	FM Transmitter, 10 kW

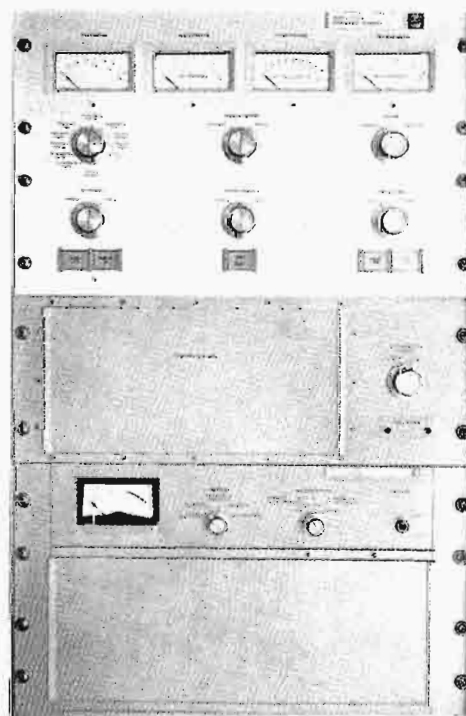

831F-1 Control Panel

831E Series FM Transmitters

The Collins 831E series includes two high-performance transmitters the 831E-1 and the 831E-1B. These two units have a power output of 5 kW and 7.5 kW respectively. Physically, they are identical except for power supply components. The Collins 310Z solid state exciter is used to supply the rf signal to the transmitter. At that point, it is amplified by a 4CX250B driver and a neutralized 4CX5000A tetrode operating in Class C. Because of the method of neutralization, tuning and output adjustments are simple and straightforward. To promote long tube life, the filament voltage is automatically controlled to within 2% of optimum value. Output is also controlled automatically by a servo system that maintains it within 2% of authorized level.

All interlocks, controls and indicators are operated by a 28-Vdc system, eliminating problems with remote control interfacing, and providing additional safety for the operator.

Filament and plate controls are located on the front panel, with a built-in 120-second delay in the plate circuit to provide for tube warmup. Overload sensors in both the driver and final amplifier monitor the transmitter's operation, and fault indicators pinpoint trouble areas, easing maintenance efforts. If a fault occurs, an automatic recycle system will attempt to re-start the transmitter either two or four times in a 30-second period, as set by the station engineer.

As in all other Collins FM transmitters, the 831E-1 and 831E-1B feature vertical component placement, and removable panels for ease of maintenance. Also, when necessary, the control panel may be removed and located up to 50 ft from the transmitter, solving installation problems and providing operation according to FCC regulations.

FM Noise Level	65 dB below 100% modulation (±75 kHz)
AM Noise Level	-55 dB rms
Altitude	Operating 7500 ft at 30°C Nonoperating 10,000 ft
Power Source	200 to 250 volts ac 50/60 Hz 3-phase. Available taps on trans- formers are for 200, 210, 220, 230, 240, and 250 volts
Permissible Line Voltage Variation	±5%. In addition, each phase volt- age shall be within 5% of the average of all three phases.
Power Requirements	Nominal 5 kW output requires 14 kVA at 0.97 power factor; nomi- nal 7.5 kW output requires 17.5 kVA at 0.97 power factor
Size	68-15/16" (175.1 cm) H; 71-1/2" (181.6 cm) W; 27-1/2" (69.8 cm) D.
Weight	2300 lbs (1025 kg)
831E-1	FM Transmitter, 5 kW
831E-1B	FM Transmitter, 7.5 kW

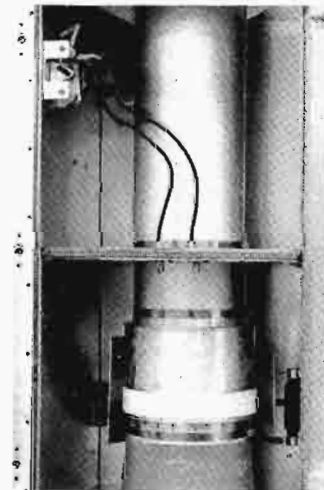

831E Cavity

831E Series specifications

Output Power	831E-1: 5 kW 831E-1B: 7.5 kW
Output Impedance	50 ohms, vswr 2:1 maximum
Frequency Range	88 to 108 MHz
Frequency Stability	±1000 Hz
Modulation Capability	±100 kHz
Audio Input Level	10 dBm ±2 dB
Audio Frequency Response	Complies with FCC standard pre- emphasis curve
Audio Frequency Distortion	Monaural: 1% 1N PTR will mea- sure like 831G-1 (0.5% or less typical) 50 to 15,000 Hz
Stereo Separation	35 dB minimum, 50 to 15,000 Hz (39 dB typical)
Harmonic Attenuation	-80 dB minimum

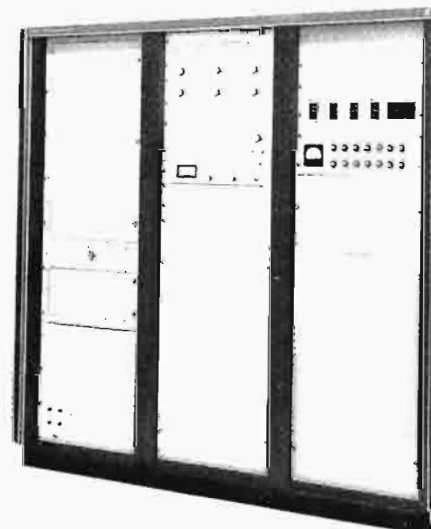

831E FM Transmitter

831D-1B FM Transmitter

For broadcasters requiring low power FM transmitters, Collins now offers an improved version of the popular 2-kW 831D-1, the 2.5-kW 831D-1B. With this increased power level, a more realistic transmitter/antenna combination may be used to provide authorized power levels.

The 831D-1B is completely solid state except for the final amplifier tube. Using a high-gain 5CX1500A, the transmitter directly amplifies a composite rf signal from the exciter, thus eliminating extra stages and components.

As in all Collins FM transmitters, the 2.5-kW 831D-1B is equipped with the dependable 310Z solid state exciter to deliver a signal that is far above standards set by the Federal Communications Commission. In a stereo application, this Collins transmitter/exciter combination will provide excellent stereo performance with a minimum separation of 35 dB guaranteed.

Featuring vertical parts layout and removable panels, the 831D-1B offers truly outstanding accessibility for maintenance and ease of installation. The entire transmitter is cooled by a high capacity blower and filament regulation that assures long tube life, and many hours of trouble-free operation. To provide further dependability, the power supply is completely solid state. These features make day to day operations simply a matter of routine maintenance.

As delivered, the 831D-1B is completely assembled and factory tested on the customer's frequency and power setting. A complete set of test data is supplied on each unit to aid the station engineer in setting up parameters of operation. For shipment, only a few components are removed, but are easily reinstalled for operation. All panels and access doors are interlocked for safety, and a grounding rod is supplied for maintenance procedures.

831D-1B specifications

Output Power	2.5 kW
Output Impedance	50 ohms, vswr 2:1 maximum
Frequency Range	88 to 108 MHz
Frequency Stability	±1000 Hz
Modulation Capability	±100 kHz
Audio Input Level	10 dBm ±2 dB
Audio Frequency Response	Complies with FCC standard pre-emphasis curve
Audio Frequency Distortion	Monaural: 1% PTR (typical 0.5% or less) 50 to 15,000 Hz Stereo: Less than 1% 50 to 15,000 Hz
Stereo Separation	35 dB minimum, 50 to 15,000 Hz (39 dB typical)
Harmonic Attenuation	-80 dB minimum
FM Noise Level	65 dB below 100% modulation (±75 kHz)
AM Noise Level	-55 dB rms

Altitude	Operating 7500 ft at 30°C Nonoperating 10,000 ft
Power Source	200 to 250 volts ac 50/60 Hz 1-phase. Available taps on transformers are for 200, 210, 220, 230, 240, and 250 volts
Permissible Line Voltage Variation	±5%.
Power Requirements	Nominal 2.5 kW output requires 4.9 kVA at 0.90 power factor.
Size	69" (175.2 cm) H; 41" (104.1 cm) W; 22-3/4" (57.8 cm) D.
Weight	850 lbs (386 kg)
831D-1B	FM Transmitter, 2.5 kW

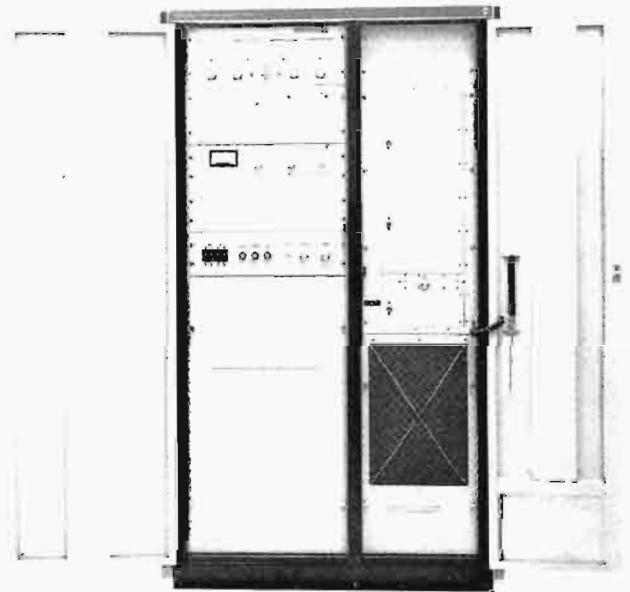

831D-1B FM Transmitter

830D-1B FM Transmitter

The Collins 830D-1B FM Transmitter is a combination of excellent engineering standards, and time-proven performance. This self-contained 1000-watt unit offers reliability, efficiency, and low cost of operation to any broadcaster requiring low power and minimum maintenance attention.

To help achieve these requirements, the 830D-1B uses fewer parts to facilitate compactness and ready access. All components including the popular 310Z Exciter and harmonic filter are contained in one attractive cabinet.

Starting the transmitter is a fully automatic operation that allows single button initiation, with automatic plate start after an appropriate time for tube warm-up. Silicon rectifiers in the power supply generate a minimum of heat, and filament voltage regulation assures long tube life.

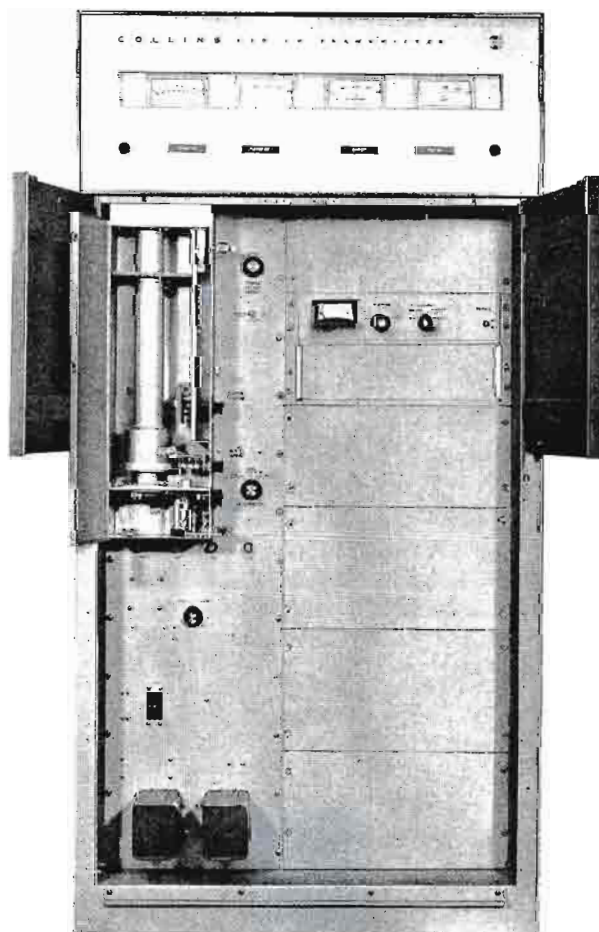

Front view, cavity open

830D-1B FM Transmitter

Vertical panel construction eliminates hidden components and allows rapid troubleshooting. A grounded shorting stick is located inside the transmitter for safety in maintenance. As a standard Collins procedure, the transmitter is tested completely on the customer's frequency for fast, trouble-free installation.

The same 310Z Exciter that drives the Collins 45-kW transmitter drives the 830D-1B. Completely solid state, the 310Z is truly an advanced design, and offers as an option, plug-in cards that give stereo and SCA capability.

830D-1B specifications

Output Power	1 kW
Output Impedance	50 ohms, vswr 2:1 maximum
Frequency Range	88 to 108 MHz
Frequency Stability	± 1000 Hz
Modulation Capability	± 100 kHz
Audio Input Level	10 dBm ± 2 dB
Audio Frequency Response	Complies with FCC standard pre-emphasis curve
Audio Frequency Distortion	Monaural: 1% PTR (0.5% typical) 50 to 15,000 Hz Stereo: Less than 1% 50 to 15,000 Hz
Stereo Separation	35 dB minimum, 50 to 15,000 Hz (39 dB typical)
Harmonic Attenuation	-80 dB minimum, 50 to 15,000 Hz (39 dB typical)
FM Noise Level	65 dB below 100% modulation (± 75 kHz)
AM Noise Level	-55 dB rms
Altitude	Operating 7500 ft at 30°C Nonoperating 10,000 ft
Power Source	200 to 250 volts ac 50/60 Hz 1-phase. Available taps on transformers are for 200, 210, 220, 230, 240, and 250 volts
Permissible Line Voltage Variation	$\pm 5\%$.
Power Requirements	Nominal 1 kW output requires 2.3 kVA at 0.90 power factor
Size	76" (193.04 cm) H; 38" (96.52 cm) W; 27" (68.58 cm) D.
Weight	776 lbs (351.99 kg)
830D-1B	FM Transmitter, 1 kW

820D-2 1-kW AM Transmitter

The entirely new 820D-2 1-kW AM Transmitter offers many new and innovative features to improve AM performance and reliability. By utilizing effective cost-control methods, Collins is now able to offer a new transmitter, of superior design, at a lower price than ever before. In addition to a lower price, the new transmitter performs up to specifications that used to apply to FM broadcasting only.

An all new cabinet design places every component within easy reach for maintenance. The modulator and final rf tubes are at shoulder height, making removal as trouble free as possible.

By using straightforward design concepts, Collins has been able to build a 1-kW AM transmitter that will operate many trouble-free hours, at a very low cost. In addition, maintenance costs have been reduced by the use of standard components and conservative ratings.

820D-2 AM Transmitter

Exciter. The exciter for the 820D-2 AM Transmitter consists of a dual oscillator to develop the necessary input to the rf driver. A two-position switch enables the operator to select the oscillator that is to be used on the air. At any point in time, the other oscillator may be used, providing a ready standby in the event of failure. The frequency of both oscillators may be adjusted from the front panel. Since quartz crystals are most stable at frequencies above the broadcast band, Collins operates them in that range, and then divides with an integrated circuit multivibrator to derive the station's frequency.

RF Driver. The rf driver is completely solid state, utilizing one 2N5039 transistor operating in Class C. To achieve the high gain that is necessary to drive the PA, the transistor circuit employs a common emitter configuration, driving a matching network consisting of a tuned secondary rf transformer.

Power Amplifier. The power amplifier is designed to deliver 1100 watts nominal output into a 50Ω load. Two long-life 5-500A pentodes are operated in parallel Class C, and are modulated in a conventional manner by a transformer-coupled modulator. Bridge neutralization is used to reduce rf intermodulation products. Power cutback to either 500 or 250 watts is possible by reducing plate voltage. The power output of the 820D-2 is controlled automatically to within 2-1/2%.

Output Network. The output network is a bandpass filter consisting of three nodes. The first node is tuned by a vacuum variable capacitor. Nodes one and two are bottom

coupled by an inductor. Nodes two and three are top coupled with an inductor which serves as the fixed adjustment for loading. Coupling circuits provide a 90° phase delay between nodes. Q distribution is such as to provide a symmetrical passband response for reduction of audio distortion at the higher modulation frequencies. Harmonic attenuation exceeds FCC requirements.

Audio Driver. Two push-pull driver stages amplify audio to drive the modulator. The relatively low voltage required by the modulator eliminates the necessity of stepping up the audio signal by means of an interstage transformer. The final stage of the audio driver is a regulated 290 Vdc, ensuring ample collector swing capability. Both driver stages operate Class A, common emitter, to achieve high gain.

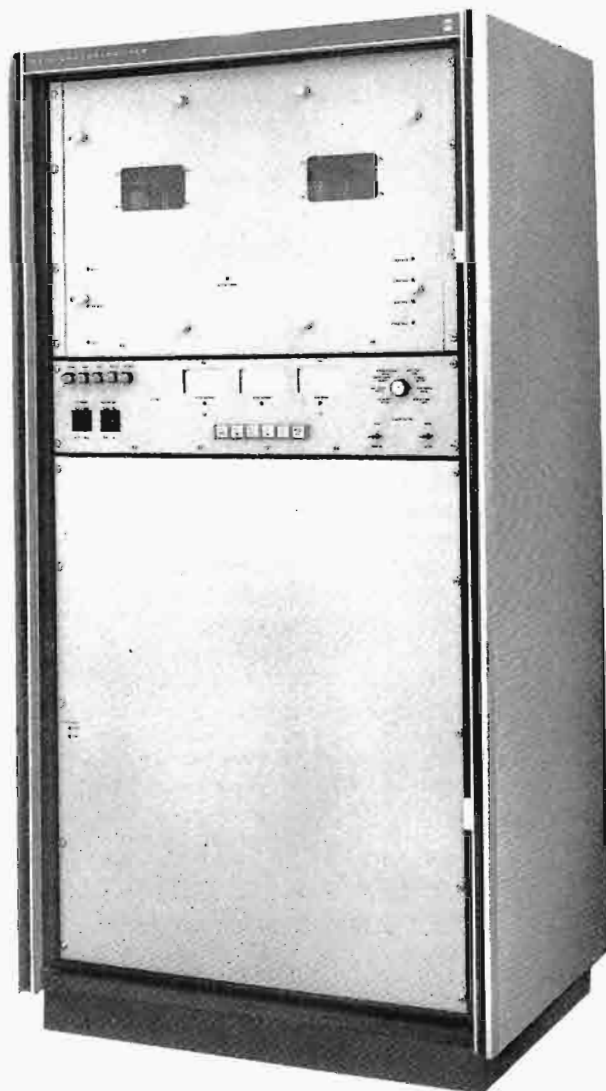

820D-2 AM Transmitter

Modulator. Two 5-500A pentodes are operated Class AB₁ push-pull, to supply a modulating signal to the PA. Transformer coupling provides correct impedance matching, while a reactor is employed in series with the plate supply to provide a path for the dc PA plate current. This transformer is a special low distortion design. At transmitter power cutback, the modulator plate voltage is reduced simultaneously with the PA plate voltage. The modulator screens are coupled together through stabilizing resistors to the screen supply. Rf bypassing is used to prevent high frequency oscillations. Modulation capability of 125% on positive peaks is assured, allowing high average modulation with a minimum of distortion. Use of the 5-500A pentodes lengthens tube life and reduces operating costs.

Metering Circuits. Individual meters are provided for measuring PA plate voltage and PA plate current. Accuracy of measurement is within 2% of full scale. An eight-position multimeter is also provided to meter additional parameters, including screen voltage, PA grid current, bias voltage, rf driver collector current, 28-Vdc supply voltage, screen current, modulator cathode current, and the 290 V supply voltage.

Power Supplies. 28-Vdc Supply: The 28-Vdc supply provides power to the control circuits, pilot lamps, and rf and audio drivers. Power to the supply is routed via the low voltage circuit breaker through a protective fuse to the transformer primary. A full wave bridge is used for rectification, while the output is filtered and regulated to reduce ripple.

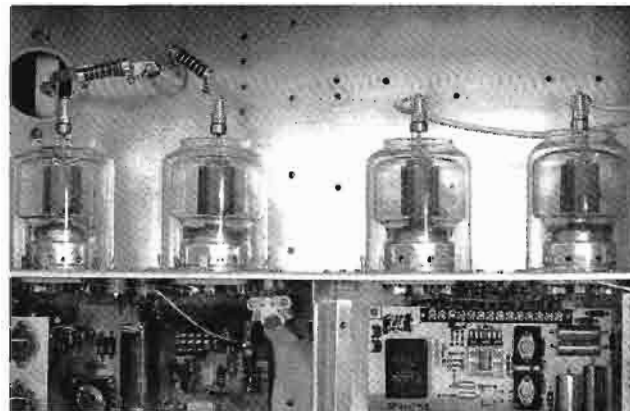

820D-2 PA Compartment

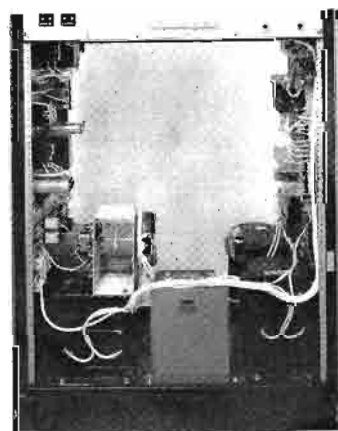

820D-2 Lower Compartment

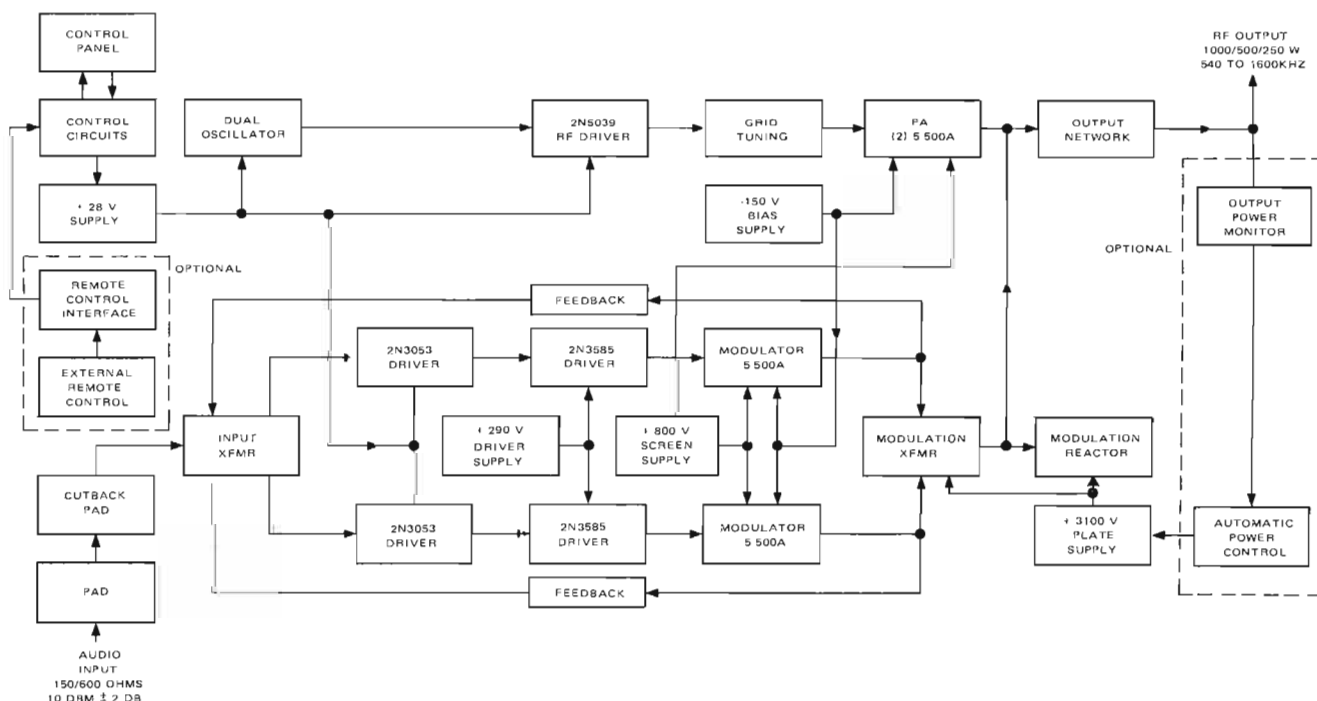

820D-2 Block Diagram

Filament Supply: PA and modulator filament voltages are regulated by an optional constant voltage transformer. Adjustment is provided for each pair of tubes by rheostats on the two filament transformer primaries.

Bias Supply: A bias voltage of -150 Vdc is developed for the PA and modulator control grids. Full-wave rectification and filtering follow transformer voltage conversion to the proper level. The bias supply is fed through the low voltage breaker, and is also fused for further protection.

Audio Driver Supply: The audio driver final stage voltage of 290 Vdc is obtained from the screen supply.

Screen Supply: The screen transformer derives its power through the high voltage breaker, and is further protected by a separate fuse.

Plate Supply: The plate supply consists of a power transformer full-wave bridge rectifier, and filter components. The transformer is equipped with taps on the primary for switching to low power operation. Transmitter power output is adjusted by a motor-driven rheostat in the power amplifier plate supply circuit. Overload protection is provided by the high voltage breaker, and by overload relays in the power amplifier and modulator circuits.

Control Circuits. Control circuits have been simplified as much as possible for safety and reliability. Complete remote control facilities are designed into the transmitter for rapid interface with any remote control unit.

Control Functions. Five pushbutton switches are provided for transmitter control. These include filament off, filament on, plate off, high power on, and low power on. Power change between full and reduced power is accomplished by depressing the proper button. Sequencing is completely automatic, requiring no plate deenergizing before change. Depressing the FILAMENT OFF switch powers down the entire transmitter, including the filaments and cooling air. No postoperative tube cooling is necessary.

Overload Protection. Excessive current in either the PA or the modulator causes a current sensitive relay to energize, removing both plate and screen voltage. Automatic recycling is included to return the transmitter to the air, while indicator lamps for both modulator and PA sections pinpoint trouble areas, and expedite troubleshooting.

Remote Control. The following functions may be remote controlled: Filament off, filament on, high power on, low power on, power increase/decrease, manual/auto power control, and remote failsafe. Also provided, are samples of plate voltage and plate current that appear on a terminal board for remote metering.

Accessibility. Accessibility on the 820D-2 is among the best available today. Component layout is straightforward and uncluttered. Tubes are at shoulder height, easing removal and replacement. All other components are accessible by removing one front panel. The 820D-2 is truly an improved version of the 820D-1, already a leader in its class!

820D-2 specifications

R-F Output	Power output capability is 1.1 kW into a 50-ohm unbalanced load. Facilities for reduced power operation are provided at either 550 or 275 watts. Other unbalanced output impedances can be supplied on special order.
Emission	Amplitude modulation (A3).
Harmonics	75 db below carrier or better.
Frequency Range	540 to 1,600 kHz.
Frequency Stability	±5 Hz, 0°C to +35°C. ±10 Hz, -10°C to +45°C. ±20 Hz, -25°C to +45°C.
Audio Input	+10 dbm ±2 db.
Response	±1 db from 50 to 10,000 Hz.
Distortion	Less than 2% from 50 to 10,000 Hz for 95% modulation.
Carrier Shift	Less than 3% from 0 to 100% modulation.
Hum and Noise	Sixty db below 100% modulation
Type of Service	Continuous duty, attended or unattended, local or remote control.
Service Conditions	Designed for continuous duty operation.
Ambient Temperature Range	-25°C to +45°C.
Ambient Humidity	Up to 95% R.H.
Altitude	Up to 7500 feet.
Power Source	208/230/240 volts, 50/60 Hz, single phase.
	Filaments .4 kw 90% PF
	Carrier 2.2 kw 90% PF
	30% Mod 2.5 kw 90% PF
	100% Mod 3.4 kw 90% PF
Size	68-3/8" H x 35-7/8" W x 24-3/8" D 173.6 cm H x 91.1 cm W x 62.6 cm D
Weight	Approximately 1100 lb (500 kg)
Part No: 622-2017-001 . . .	820D-2 Transmitter
Part No: 627-9734-001 . . .	Automatic Power Control-optional
Part No: 627-9721-001 . . .	Remote Control Relay System-optional
Part No: 627-9733-001 . . .	Filament Voltage Regulator-optional
Part No: 627-9735-001 . . .	50 Hz Conversion Kit-optional

820E/F AM Transmitters

Collins 820E/F-1 series of broadcast transmitters is one of the most extensively transistorized series of transmitters available in the 5-kW to 10-kW power range. The series feature solid state devices in low level audio and driver, power supply circuits, and the rf exciter. In addition, this line of transmitters is capable of modulation levels in excess of 125%, with an optional modulation kit allowing higher average positive peaks than ever before.

The exciter used in the 820E/F-1 has a highly stable dual ovenless crystal oscillator operating in the 2.1-MHz to 4.3-MHz range, with division to standard broadcast frequencies by integrated circuit digital dividers. The 10-kW model uses a total of six tubes in the rf driver, power amplifier, and modulator circuits, and requires only two tube types. The 5-kW model uses one less tube in the final rf section.

Collins designed this transmitter for rapid space-saving installation, as well as extended performance. The cabinet measures 69 inches high, 67-7/16 inches wide, by 32 inches deep. All power supply components are completely self-contained. For attended operation, all metering and control of the transmitter is accomplished from a control panel which may be located away from the transmitter, and requires no remote control authorization.

Extended Control Panel. The transmitter is suitable for installation at an unattended site, and may be remotely controlled from a distant studio location in the conventional manner. As a convenience for attended operation and maintenance the meters and operating controls are grouped on a 12-1/4- x 19-inch control panel.

RF Exciter. An all solid state unit, the 310W-1 Exciter offers increased frequency stability through operation of the oscillator at two or four times the station frequency. Division to standard broadcast frequencies is obtained through the use of digital integrated circuits. The exciter can be located externally of the transmitter with up to 250 feet of coaxial interconnecting cable.

RF Driver. The rf driver uses two 6146B tubes in parallel, operating Class C. Tuned grid and tuned plate circuits are employed, with frequency monitor sampling taken from the plate tank coil.

Output Network. Low pass L-sections transform the 50 Ω output impedance to 1000 Ω plate impedance for the 10-kW transmitter, and to 2000 Ω for the 5-kW version. The combined network consists of three series inductances, and three shunt capacitances, plus a second harmonic shunt trap to ground. Overall phase through the networks is -360 $^\circ$,

giving a favorable plate impedance characteristic when operating into loads within the EIA limit for "normal" loads. Motor-driven variable vacuum capacitors in the PA tuning and loading circuits, are controlled from switches on the extendable control panel. PA loading is used to adjust transmitter power output, and can be extended to the remote point through a conventional remote control unit. A phase comparator circuit is used in the PA stage to automatically control the PA tuning motor as loading changes. Tuning corrections occur at a rapid rate, well within the time required for loading changes. To assure fail-safe operation, the automatic tuning adjustment is disabled until loading changes take place. A manual/automatic tuning switch is provided on the control panel to disable the automatic mode when it is desired to perform manual tuning.

As in every transmitter that Collins produces, the 820E/F-1 series feature superior accessibility and ease of maintenance through the use of vertical parts placement and straightforward design concepts. All cabinet panels may be removed for maintenance and troubleshooting. All voltage test points are brought out to the front panel, and all components are accessible with the removal of the front panels. When space is at a premium, this feature alone will save many hours of valuable time.

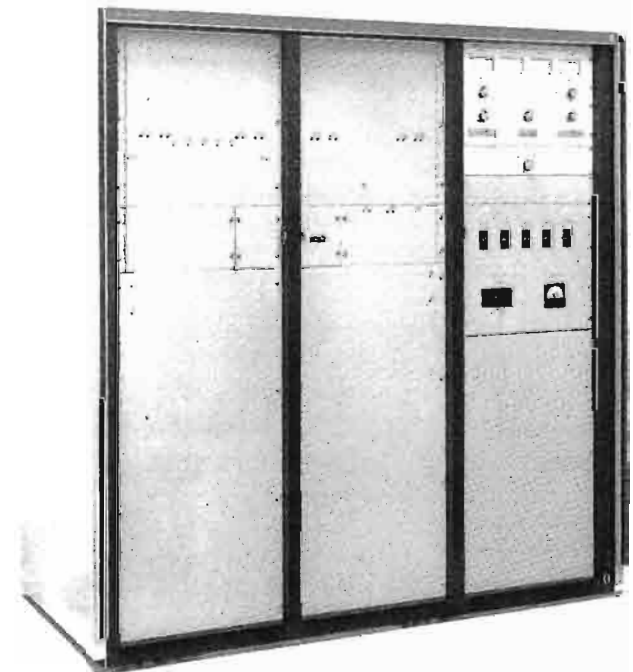

820E/F AM Transmitter

820E/F specifications

Frequency Range	540-1,600 kHz
Power Source	208/240 volts, $\pm 5\%$, 50/60 Hz, three-phase.
Power Output	820E-1: 5.5 kw max. with built-in reduction to 1 kw. 820F-1: 10.6 kw max. with built-in reduction to 5 kw.
Frequency Stability	Trimmer capacitors provided on the RF exciter for adjusting crystals to exact center frequency. Stability as follows: ± 5 Hz, 0°C to $+35^{\circ}\text{C}$ (32°F to 95°F) ± 10 Hz, -10°C to $+45^{\circ}\text{C}$ (14°F to 113°F)
Outer Impedance	Designed for feeding standard 50-ohm coaxial transmission lines. Matching to other impedance options can be supplied on special order.
Harmonic and Spurious Radiation	Complies with or exceeds FCC regulations regarding harmonic and spurious radiation.
Modulation Characteristics	Equipment incorporates high level modulation with most desirable response characteristics for broadcast use.
Audio Input Impedance	150/600 ohm, balanced.
Audio Input Level	+10 dbm ± 2 db.
Audio Frequency Response	Typically ± 1 db from 50 Hz to 10,000 Hz.
Audio Frequency Distortion	Less than 3% from 50 to 7,500 Hz for 95% modulation.
Noise	60 db below 100% modulation, maximum
Carrier Shift	Less than 3% from zero to 100% modulation.

Ambient Temperature Range	-25°C to $+45^{\circ}\text{C}$ (-13°F to 113°F).
Altitude:	Up to 7,000 feet; higher altitudes on special order.
Size	69" high x 67-7/16" wide x 32" deep (175 cm. x 171 cm. x 81 cm.).
Total Weight Including Transformers	820E-1 - 2,000 lbs. (910 Kg.); 820F-1 - 2,450 lbs. (1,115 Kg.).

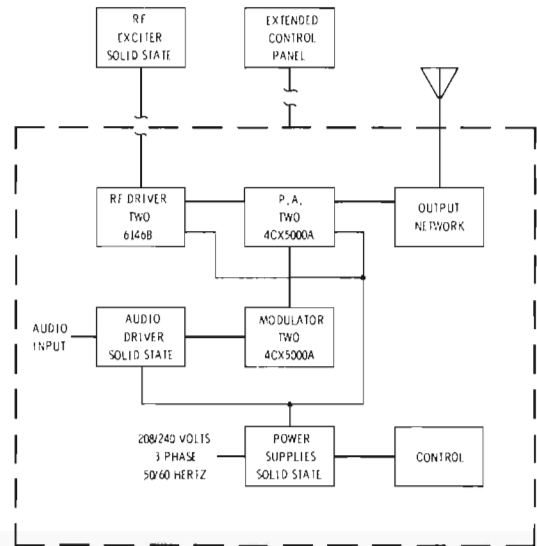

820E/F Block Diagram

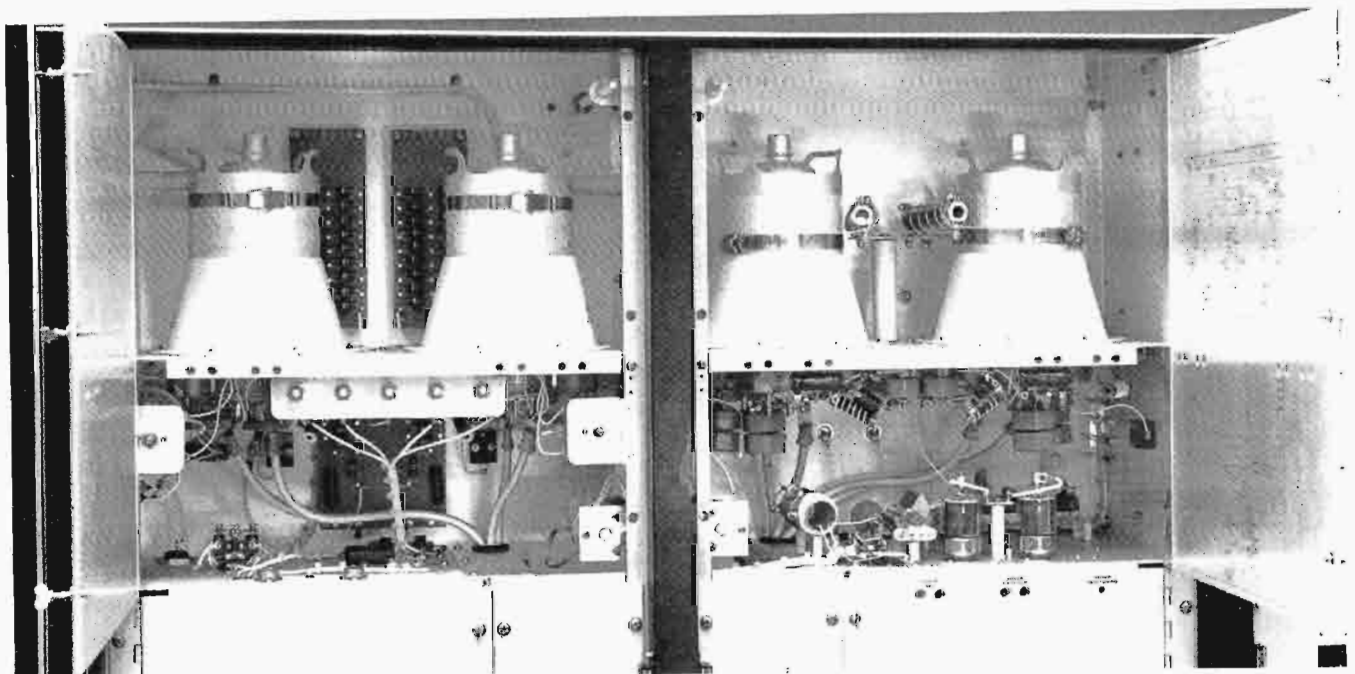

820E/F PA Compartment

COLLINS BROADCAST EQUIPMENT

CATALOG No. 47

TABLE OF CONTENTS

FM Transmitters	1-2
Automatic Switching	1-5
Exciter, Stereo, & SCA Generators	1-7
AM Transmitters	1-12
Phasing Equipment	1-17
FM Antennas	2-2
Towers & Accessories	2-7
Transmission Line & Fittings	2-9
Audio Consoles	3-2
Turntables & Accessories	3-5
Tone Arms & Cartridges	3-6
Limiters & Amplifiers	3-8
Cartridge Tape Systems & Accessories	3-11
Reel Tape Systems & Accessories	3-14
Microphones & Accessories	3-16
Speaker Systems	3-19
Headsets	3-20
Audio & Studio Accessories	3-21
STL Equipment	4-2
Remote Pickup Equipment	4-6
Monitoring Equipment	4-10
Test Equipment	4-14
Tables, Charts, & Graphs	5-2
Ordering Information	5-15
Warranty Information	5-16



Equipment descriptions in this catalog are condensed so that the complete line of broadcast units supplied by Collins Radio Company can be shown. For more information on any of these units, you are invited to contact your Collins Broadcast Sales Engineer or Collins Radio Company, Broadcast Marketing, Dallas, Texas.

Customers in countries other than the United States are invited to contact the nearest International Sales Office or Collins International Division, Dallas, Texas.

All specifications contained within are subject to change without notice.



TRANSMITTER POWER RANGE MATRIX

TYPE NO.	250 W	1 KW	4 KW	7.5 KW	20 KW	40 KW	45 KW
	500 W	2.5 KW	5 KW	10 KW	22.5 KW		
831H-1B						█	█
831H-1						█	█
831G-1B					█	█	
831G-1					█	█	
831F-1				█	█		
831E-1B			█	█			
831E-1			█	█			
831D-1B	█	█					
830D-1B	█	█					
820F-1				█	█		
820E-1		█	█	█			
820D-2	█	█					

FM and AM TRANSMITTERS & ACCESSORIES

831H-1 (40-kW)/831H-1B (45-kW) Transmitters

The Collins 831H series of FM transmitters provides the broadcaster with a combination of high power, state-of-the-art design, and low cost of operation through attention to quality engineering, precision manufacturing, and the use of conservatively rated components. In addition, human engineering has been incorporated in the design concept to anticipate customer problems before they occur, and to provide a product that will be able to fulfill the needs of both small and large market stations. Every effort has been made to provide a modern, dependable, product, at a competitive price. The Collins 831H series transmitters offer the following features that help to make day to day operation as simple and trouble free as possible.

- Automatic power output control
- Automatic filament regulation
- Automatic overload recycling
- Overload fault indicators
- Completely self-contained
- Ease of accessibility
- Conservative component ratings

Automatic power output control assures that maximum authorized power is available at all times. Once the output level has been set, no further adjustments are needed.

Automatic filament voltage regulation to within 2% of optimum level extends tube life far beyond normal hours.

Automatic overload recycling assures fast return to the air after minor interruptions. An internal card may be strapped for either two or four recycle sequences in a 30-second time frame. If resumption of normal operation isn't possible after this recycle attempt, the transmitter powers down completely, and thus prevents component failure due to overloading. This feature is especially helpful in a remote control operation. In addition, fault indicator lights pinpoint trouble areas and help to expedite troubleshooting. Thus, even in the event of a failure, "off air" time is kept to a minimum.

The entire transmitter is self-contained, including harmonic filter and transformer. There are no external components to be concerned with, except normal monitoring and audio processing equipment.

Accessibility for both troubleshooting and routine maintenance is made extremely simple by the use of vertical component placement, and easily removable panels. Although panels on all four sides of the transmitter may be removed, only the front ones need be for normal maintenance requirements. This allows the transmitter to be operated against a wall in a confined area.

Another concept that is part of every Collins product, whether it be a hybrid microcircuit, or a complex computer-controlled space communications system, is conservatism in ratings of components. By providing all the communications equipment for all the manned space missions, Collins demonstrated its ability to design and build the ultimate in reliable products.

831H-1/1B

The 831H-1 and 831H-1B Transmitters are essentially identical in design concept, with the 831H-1 rated at 40 kW and the 831H-1B at 45 kW RF power output. Both transmitters utilize two 831G Amplifiers combined into a single output to feed one transmission line. A single 310Z Exciter is used to drive both amplifiers, thus eliminating problems with phase relationships. If desired, two exciters may be utilized to provide a "hot standby" mode of operation.

Since two completely separate power amplifiers are used to achieve total power output, one amplifier may be used in the event the other fails. In addition, the system may be set up so that one amplifier may be serviced while the other remains on the air. With the addition of the optional 377C-1 and 377D-1 Exciter and Combiner Controls, the 831H-1 and 831H-1B Transmitters may be operated into either the antenna at full power, the dummy load at full power, the antenna at half power, or any combination that may be required for maintenance.

Both power amplifiers use a neutralized 4CX15000A tube operating Class C. Giving typically 73% efficiency. The grid circuit is a PI network, tuned with a single vacuum variable capacitor. Motor-driven tuning and loading capacitors provide output adjustment, while a sliding plate provides coarse adjustment for the plate cavity. RF power is automatically held to within $\pm 2\%$ of a predetermined value by a circuit that compares actual power output to a predetermined level set by the station engineer. Long tube life is assured by an automatic voltage regulator system that maintains the filaments within 2% of optimum value. To provide ease of remote control and safety, all interlock, control, and indicator functions operate on 28 Vdc.

PHASING EQUIPMENT

For installations requiring phasing equipment, Collins offers a complete line of custom designed units. Whether an installation is a two-tower directional or a twelve-tower system, Collins can provide the necessary engineering and hardware to match it to your transmitter.

Engineered into each installation, are easily adjusted networks, high stability, adequate voltage and current safety

factors, and maximum economy. A customer's requirements, as specified by his consulting engineer, are strictly adhered to, and designs are submitted for approval before actual construction is begun. To expedite installation and operation, data sheets are supplied that indicate settings for both the coils and capacitors.

Collins phasing gear can be supplied in cabinets that match the entire Collins transmitter line. All doors and panels have built-in interlocks for safety, and may be interfaced with automatic switchover controls and remote control systems.

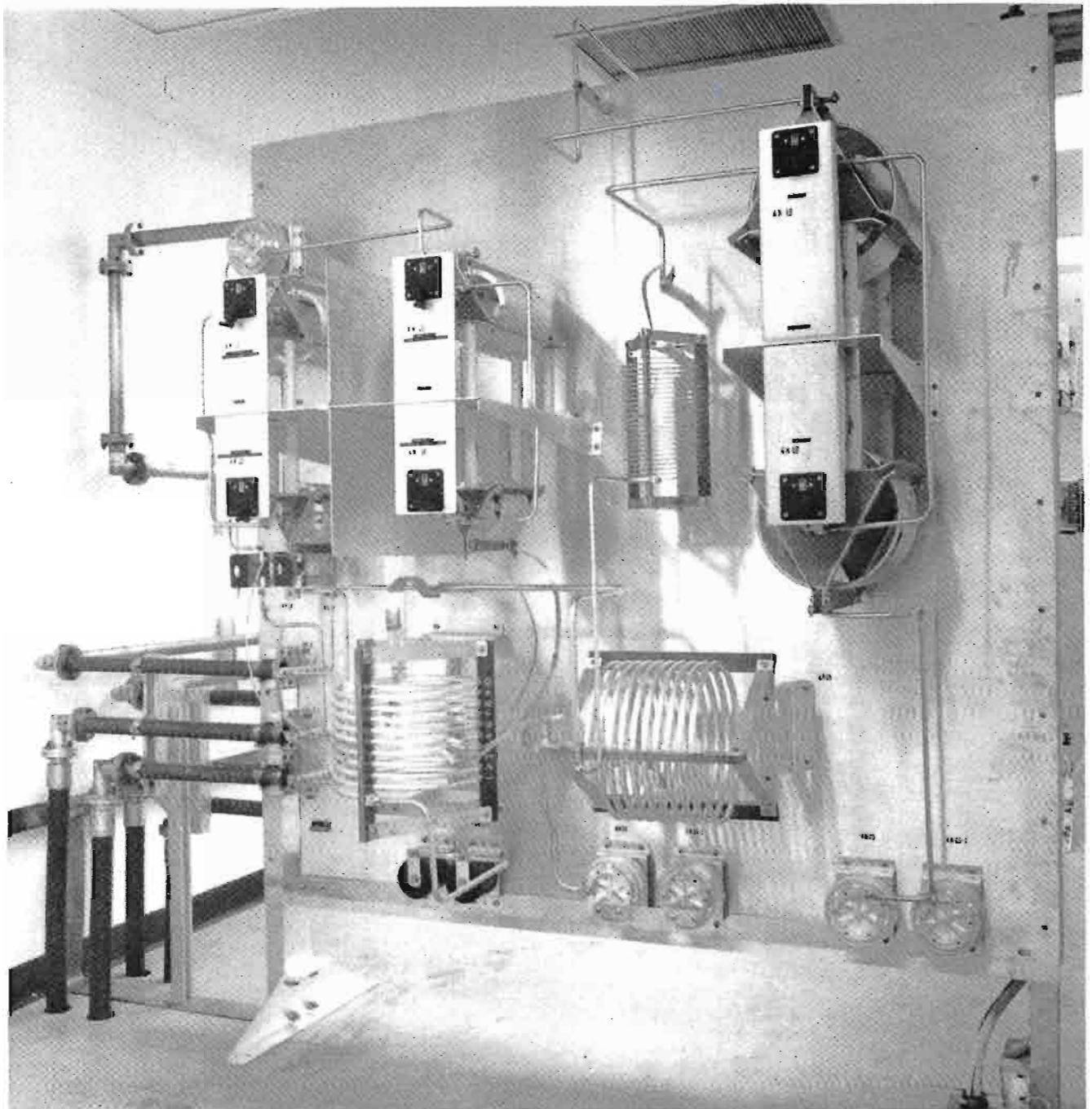

Typical Collins Phasing Network.



Part of Transmitter Assembly Line at Collins.



ANTENNAS
TOWERS
TRANSMISSION LINE
& ACCESSORIES

FM ANTENNAS

Collins offers a complete line of high-medium-and low powered circularly polarized FM antennas, ideal for monaural, stereo, and multiplex FM broadcasting. They radiate a circularly (clockwise) polarized wave for improved reception in FM automobile radios and in home receivers. These Collins antennas are designed for rugged service in all types of weather conditions. The design is flexible and permits side or top mounting on any type of tower. Standard mounting brackets are supplied; custom brackets are available at extra cost. Standard power split is 50/50 with other ratio available on the high power series.

Collins also offers a complete line of horizontally polarized (37m series) and vertically polarized (300C Series) FM antennas. They are available in one to sixteen-bay configurations. Complete details may be obtained from your Broadcast Sales Representative.

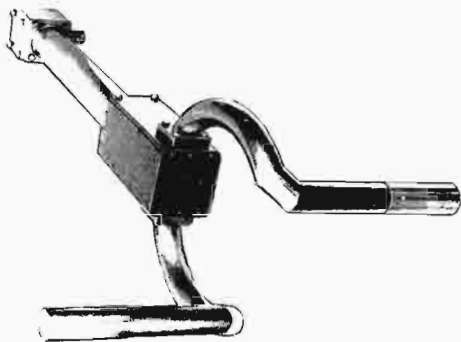

37CP ELEMENT



425 ISOLATION UNIT

Type	Part Number	Description
37CP-1	124-0061-383	Single-bay
37CP-2	124-0061-385	Two-bay
37CP-3	124-00061-387	Three-bay
37CP-4	124-0061-389	Four-bay
37CP-5	124-0061-391	Five-bay
37CP-6	124-0061-393	Six-bay
37CP-7	124-0061-395	Seven-bay
37CP-8	124-0061-397	Eight-bay
37CP-9	124-0061-864	Nine-bay
37CP-10	124-0061-399	Ten-bay
37CP-11	124-0061-865	Eleven-bay
37CP-12	124-0061-401	Twelve-bay
37CP-13	124-0061-866	Thirteen-bay
37CP-14	124-0061-403	Fourteen-bay
37CP-15	124-0061-867	Fifteen-bay
37CP-16	124-0061-405	Sixteen-bay

37CP Series (High-Power)

FREQUENCY RANGE:	Factory tuned to one frequency in the 88-to 108-MHz band.
POLARIZATION:	Circular, clockwise.
POWER GAIN:	See table.
AZIMUTHAL PATTERN:	Horizontal: ± 2 dB in free space. Vertical: ± 2 dB in free space.
VSWR AT INPUT (without field trimming):	Top mounting: 1.1:1 or better. Side mounting: 1.5:1 or better.
INPUT CONNECTION:	3-1/8", 50 ohm EIA female flange. (End fed through 9 bays; 10, 12, 14, and 16 bays are center fed; 11, 13, and 15 bays are fed at a point 1/2-bay below center of antenna.)
POWER INPUT RATING (one bay):	20 kW.
WINDLOAD (see table):	50 lb/sq ft for flat surfaces; 33 lb/sq ft for cylindrical surfaces.
DIMENSIONS:	See table.
WEIGHT:	See table.

ACCESSORIES AND SPECIAL FEATURES

37CP	124-0083-426	Radomes. One per bay required.
37CP	124-0061-469	Deicers, factory installed, 300 watt, with interbay wiring. One per bay required. Specify 115V or 230V.
37CP	124-0061-676	Replacement heater element, 150 watt, (two required per bay). Specify 115V or 230V.
37CP	124-0083-025	Deicers, factory installed, 500 watt, with interbay wiring. One per bay required. Specify 115V or 230V.
37CP	124-0061-868	Replacement heater element, 250 watt, (two required per bay). Specify 115V or 230V.
C22B	124-0032-415	Temperature control, 15 ampere, 115 volt.
NTN	124-0083-644	Deicer contactor, in weatherproof housing, 220 volt, 50 ampere.
37CP	NPN	Charge for first null fill.
37CP	NPN	Charge for beam tilt, specify angle.
37CP	NPN	Charge for other than 50/50 (horizontal/vertical) power split, specify ratio.
403	NPN	ER, AM/FM isolation unit, 10kW FM, 3-kV AM, 1-5/8 inch line
403A	124-0052-907	ER, AM/FM isolation unit, 10 kW FM, 3-kV AM, 3-1/8 inch line.
425	124-0061-613	ER, AM/FM isolation unit, 25 kW FM, 3-kV AM, 3-1/8 inch line.

37CP CIRCULARLY POLARIZED FM ANTENNA WITH 3-1/8" FEED

TYPE	POWER GAIN		LENGTH FT-IN	WEIGHT LB INCLUDING BRACKETS	WIND LOAD LB 112 MPH 50/33 PSF	WEIGHT LB WITH RADOMES AND BRACKETS	WIND LOAD LB WITH RADOMES 50/33 PSF
	HORIZ	VERT					
37CP-1	0.438	0.438	2-5	84	144	104	265
37CP-2	0.947	0.947	12-3	184	318	224	560
37CP-3	1.48	1.48	22-1	274	492	334	855
37CP-4	2.02	2.02	31-10	364	666	444	1150
37CP-5	2.58	2.58	41-8	454	840	554	1445
37CP-6	3.13	3.13	51-5	544	1014	644	1740
37CP-7	3.69	3.69	61-3	634	1187	774	2034
37CP-8	4.26	4.26	71-0	724	1361	884	2329
37CP-9	4.82	4.82	80-10	835	1608	1015	2697
37CP-10	5.40	5.40	90-7	925	1782	1125	2992
37CP-11	5.96	5.96	100-5	1015	1956	1235	3287
37CP-12	6.53	6.53	110-3	1105	2130	1345	3582
37CP-13	7.10	7.10	120-0	1195	2303	1455	3867
37CP-14	7.67	7.67	129-10	1285	2477	1565	4171
37CP-15	8.24	8.24	139-7	1375	2651	1675	4466
37CP-16	8.81	8.81	149-5	1465	2825	1785	4761

LPC Series (Medium Power)

This special group of antennas have a 3-1/8" center-fed connection with a field power split of 50/50.

FREQUENCY RANGE:	Factory-tuned to one frequency in the 88- to 108 MHz band.
POLARIZATION:	Circular, clockwise.
POWER GAIN:	See table.
AZIMUTHAL PATTERN:	Horizontal: ± 2 dB in free space. Vertical: ± 3 dB in free space.
VSWR AT INPUT (without field trimming):	Top mounting: 1.2:1 or better. Side mounting: 1.5:1 or better.
INPUT CONNECTION:	3-1/8" 50-ohm EIA female flange, center feed only.
POWER INPUT RATING:	12 kw.
WINDLOAD: (see table)	50 lb/sq ft for flat surfaces; 33 lb/sq ft for cylindrical surfaces.
DIMENSIONS:	See table.
WEIGHT:	See table.
INTERCONNECTING FEED LINE:	3-1/8"

LPC Series (Medium Power)

Type	Part Number	Description
LPC-4	124-0052-912	Four-bay
LPC-5	124-0052-913	Five-bay
LPC-6	124-0052-914	Six-bay
LPC-7	124-0052-915	Seven-bay
LPC-8	124-0052-916	Eight-bay
LPC-9	124-0052-917	Nine-bay
LPC-10	124-0052-918	Ten-bay
LPC-11	124-0052-919	Eleven-bay
LPC-12	124-0052-920	Twelve-bay



LPC ELEMENT (MEDIUM & LOW POWER)

LPC SERIES (MEDIUM POWER) ACCESSORIES AND SPECIAL FEATURES

NTN	NPN	Radomes. One per bay required.
NTN	NPN	Deicers, factory installed, 300 watt, with interbay wiring. One per bay required. Specify 115V or 230V.
NTN	124-0061-676	Replacement heater element, 150 watt, (two required per bay). Specify 115V or 230V.
C22B	124-0032-415	Temperature control, 15 ampere, 115 volt.
NTN	124-0083-644	Deicer contactor, in weatherproof housing, 220 volt, 50 ampere.
LPC	NPN	Null fill
LPC	NPN	Beam tilt
403A	124-0052-907	ER AM/FM isolation unit, 10 kW FM, 3-kV AM, 3-1/8-inch line.

LPC Series (Low Power)

This group of antennas has a 1-5/8" end fed connection only, with a fixed power split of 50/50.

FREQUENCY RANGE:	Factory-tuned to one frequency in the 88- to 108-MHz band.
POLARIZATION:	Circular, clockwise.
POWER GAIN:	See table.
AZIMUTHAL PATTERN:	Horizontal: ± 2 dB in free space. Vertical: ± 3 dB in free space.
VSWR AT INPUT (without field trimming):	Top mounting: 1.2:1 or better. Side Mounting: 1.5:1 or better.
INPUT CONNECTION:	1-5/8" 50-ohm EIA female flange, end feed only.
POWER INPUT RATING:	One-bay: 3 kw. Two bay: 6 kw. 3 to 8-bay: 7.5 kw.
WINDLOAD (see table):	50 lb/sq ft for flat surfaces. 33 lb/sq ft for cylindrical surfaces.
DIMENSIONS:	See table.
WEIGHT:	See table.
INTERCONNECTING FEED LINE:	1-5/8".

Type	Part Number	Description
LPC-1	124-0083-617	Single bay. Maximum power input rating is 3 kW.
LPC-2	124-0083-618	Two-bay. Power rating is 6 kW.
LPC-3	124-0083-619	Three-bay. Power rating on this and through the LPC-8 is 7-1/2 kW.
LPC-4	124-0083-620	Four-bay
LPC-5	124-0083-621	Five-bay
LPC-6	124-0083-622	Six-bay
LPC-7	124-0083-623	Seven-bay
LPC-8	124-0083-624	Eight-bay

LPC SERIES (LOW POWER) ACCESSORIES AND SPECIAL FEATURES

NTN	NPN	Radomes. One per bay required.
NTN	NPN	Deicers, factory installed, 300 watt, with interbay wiring. One per bay required. Specify 115V or 230V.
NTN	124-0061-676	Replacement heater element, 150 watt, (two required per bay). Specify 115V or 230V.
C22B	124-0032-415	Temperature control, 15 ampere, 115 volt.
NTN	124-0083-644	Deicer contactor, in weatherproof housing, 220 volt, 50 ampere.
403	124-0052-906	ER AM/FM isolation unit, 10 kW FM, 3-kV AM, 1-5/8-inch line.

LPC CIRCULARLY POLARIZED FM ANTENNA WITH 1-5/8" END FEED

TYPE	POWER GAIN		LENGTH FT-IN	WEIGHT LB INCLUDING BRACKETS	WIND LOAD LB 112 MPH 50/33 PSF	WEIGHT LB WITH RADOMES AND BRACKETS	WIND LOAD LB WITH RADOMES 50/33 PSF
	HORIZ	VERT					
LPC-1	0.438	0.438	2-5	38	78	56	161
LPC-2	0.947	0.947	12-3	81	173	117	338
LPC-3	1.48	1.48	22-1	124	268	178	515
LPC-4	2.02	2.02	31-10	167	364	239	693
LPC-5	2.58	2.58	41-8	210	458	300	870
LPC-6	3.13	3.13	51-5	253	554	361	1047
LPC-7	3.69	3.69	61-3	296	649	422	1224
LPC-8	4.26	4.26	71-0	339	744	483	1402

LPC CIRCULARLY POLARIZED FM ANTENNA WITH 3-1/8" CENTER FEED

TYPE	POWER GAIN		LENGTH FT-IN	WEIGHT LB INCLUDING BRACKETS	WIND LOAD LB 112 MPH 50/33 PSF	WEIGHT LB WITH RADOMES AND BRACKETS	WIND LOAD LB WITH RADOMES 50/33 PSF
	HORIZ	VERT					
LPC-4	2.02	2.02	31-10	204	435	276	764
LPC-5	2.58	2.58	41-8	247	530	337	941
LPC-6	3.13	3.13	51-5	290	625	398	1118
LPC-7	3.69	3.69	61-3	333	720	459	1296
LPC-8	4.26	4.26	71-0	376	815	520	1473
LPC-9	4.82	4.82	80-10	419	910	581	1650
LPC-10	5.40	5.40	90-7	462	1005	642	1828
LPC-11	5.96	5.96	100-5	505	1100	703	2005
LPC-12	6.53	6.53	110-3	548	1195	764	2182

AM AND FM TOWERS

Collins furnishes a wide selection of both self-supporting and guyed antenna towers custom designed to meet the requirements of any AM or FM installation.

Towers are normally supplied with a protective coating of rust inhibitive paint prior to shipment, although they can be supplied with a galvanized finish at a slightly higher price. Galvanized is recommended in locations where the tower will be subjected to salt water spray, extreme humidity or other corrosive conditions. The finish coat is normally supplied by the tower erector and is in keeping with FAA requirement.

All hardware, fittings, guy insulators, anchor steel and base insulator (where required) are supplied with each tower. The applicable FCC (FAA) lighting kit and wiring are also provided.

COPPER GROUND WIRE

Bare #10 copper ground wire is used for ground radials. Wire attaches to mesh ground screen.

Weight: 31.8 ft per lb
Part No. 421 1010 000

HUGHEY AND PHILLIPS RING TRANSFORMER

For use wherever 60-Hz energy must be transferred across two points with very low capacitance or at very high voltages. Provides a highly reliable, low capacity means of supplying power across base insulator or insulated radio towers employed as radiators. Their relatively large spacing and low capacity between windings make these isolation transformers desirable for use in directional arrays, and especially with radiators that develop very high voltages across the base insulators. No tuning or rf adjustments are necessary. Available in load capacities of 1750 watts (Model TI 2017) and 3500 watts (Model TI 2035) 115/230 volts. Mounting hardware not supplied.

Part No. 097 6920 00 (Type TI 2017)
Part No. 099 0365 00 (Type TI 2035)



COPPER GROUND STRAP

This fine quality copper ground strap is available in four sizes 4 in. by 0.032 in. (4.02 ft per lb.), and 4 in. by 0.032 in. (2.01 ft per lb.).

Part No. 097 1445 00 (2-in. strap)
Part No. 097 1144 000 (3-in. strap)
Part No. 099 2689 00 (6-in. strap)
Part No. 097 0811 00 (4-in. strap)

MESH GROUND SCREEN

Expanded copper mesh ground screen is for use beneath base of antenna tower to increase soil conductivity. Available in 8- by 24-ft sheets.

Part No. 013 0107 00

FISHER-PIERCE 63305-DB BEACON LIGHT CONTROL

Designed to mount in a standard commercial meter socket. The 63305-DB will automatically control broadcast tower lights directly or with auxiliary contactors. Adjustable potentiometer allows adjustment for operation from 0 to 50 footcandles.

Power Requirements: 105 to 130 volts, 50/60 Hz
Built-in Load Contactor: Single Pole, Single Throw, Double Break, 30A
Load Rating: 3000 watts
Part No. 124 0032 559

COLLINS 172G-1 DUMMY ANTENNA

This air-cooled unit provides a load to dissipate transmitter output for off-the-air testing. Consisting of eight ferrule type, non-inductive resistors, with insulated end brackets and clips, it may be mounted on the transmitter or adjacent wall. The 172G-1 has an impedance of 52 ohms.

Power Rating: 1 kW
Size: Approx. 6 in. W, 9 in. H, 12-1/2 in. D (15.24 cm W, 22.86 cm H, 31.75 cm D)
Weight: 5 lb (2.27 kg)
Part No. 522 1410 004

STATES WG-50 DUMMY ANTENNA

An air-cooled 50-ohm rf load that will dissipate the output of the Collins 820E/F AM transmitters.

Part No. 124 0061 794 (WG-50) 7.5 kw
Part No. 124 0061 801 (Catalog No. 338-32J) 15 kw

IC-1 ISOLATION COIL

The IC-1 Isolation Coil provides isolation for the phase sampling loop line in directional arrays, presenting a high impedance for the line across the base insulator of the AM tower. The unit consists of a phenolic coil form wound with approximately 37 turns of RG8/U or similar solid dielectric line.

Inductance: Approx. 180 microhenry
Size: 18" L, 10" dia. (46 cm L, 25.4 cm dia.).
Weight: 6 lb (2.7 kg).

COLLINS ANTENNA CURRENT TRANSFORMER

The antenna current transformer is used with remote thermocouple and meter for remote monitoring of antenna current up to 25 amperes. Thermocouple is not included.

Part No. 543 3917 003

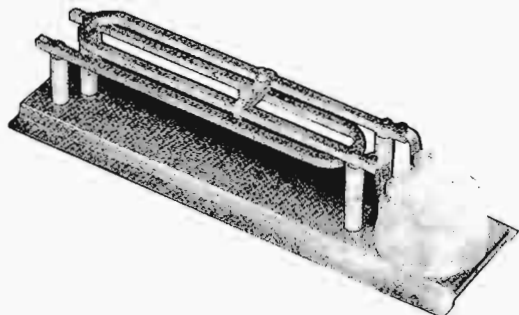

TOWER LIGHTING FILTER CHOKES

LC-2 two wire, 2000 watts

LC-3 three wire, 2000 watts

aluminum weatherproof housing optional item available

JOHNSON RF CONTACTORS

The 145-100 and 145-200 contactors are especially designed for high voltage radio frequency switching and dc voltage switching in high voltage rectifier circuits. They require no holding power and will operate with a momentary application of voltage.

Standard contactors are supplied with four auxiliary switches: two normally-closed for control of solenoid voltage and two normally-open for operation of signal lamps or other related functions. Solenoids are wired for 220 v, 50-60 Hz, or can be strapped for 110 v.

	Max. Solenoid Current	Max Contact Rating (at 2 MHz)
Part No. 410 0209 000	4 A	17 kv, 25 A
Part No. 410 0210 000	4 A	17 kv, 25 A
Part No. 410 0211 000	8 A	22 kv, 25 A
Part No. 410 0212 000	8 A	22 kv, 25 A

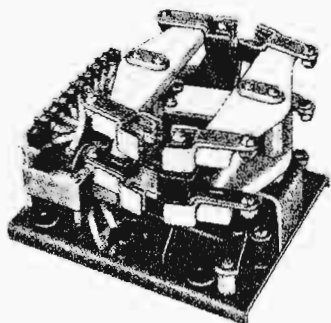

RESEARCH SAMPLING LOOP

The 601-series adjustable phase sampling loops sample the phase relationship of rf energy in the 550 to 1600 kHz range. The loops are constructed of heavy stainless steel and terminate in a type "N" female plug.

NPN 601-48 Loop, 48" x 12"

NPN 601-91 Loop, 91" x 12"

Part No. 097 6124 000 Hanger adapter for angle power leg (2 required) type 13555A.

Part No. 097 6745 000 Hanger adapter for round power leg (2 required) type 13550.

Part No. 097 6746 000 Type 14063 insulator (4 required)

Part No. 124 0061 174 Type "N" male plug

FEED-THROUGH BOWL INSULATORS

Designed to carry rf transmission line through a wall. Assembly includes glass bowls, cork gasket, steel mounting with six 3/16 in. mounting holes. Bowl is 6-15/16 in. max. diameter and 4-3/8 in. high. Mounting flange: 7-3/4 in. diameter. Fittings include spun aluminum corona shield, 1/2 in.-13 threaded and stud except 135-15-4 which has 5/8 in.-18 threaded stud (hollow), washers, and nuts.

Part No. 097 1501 000 (Type 135-15-001)

One bowl and fittings, 10-1/4 in. stud.

Part No. 097 6673 000 (Type 135-15-003)

Two bowls and fittings, 16 in. stud. for walls up to 4 in. thick

Part No. 097 5646 000 (Type 135-15-007)

Two bowls and fittings, 24 in. stud for walls up to 12 in. thick

LTU ANTENNA TUNING UNITS

The Collins LTU series of antenna tuning units are custom-designed for each individual application and are available in either 1 kW, 5 kW, 10 kW, or 25 kW power ratings. They are mounted in a weatherproof aluminum housing with full-width wraparound door. A window facilitates reading of the antenna current meter. The meter is actuated by an external operating handle. The custom-designed full "T" network uses high quality, conservatively rated components. A silver-plated bus, located at the bottom of the housing provides a ready low resistance connection to the antenna ground system. A special terminating connector allows connection to any coaxial cable with a one-inch outer conductor diameter or smaller. Other sizes may be accommodated as required. The housing is finished with light-colored paint to minimize internal temperatures; weather-proof screened vents allow air circulation.

Part No. NPN LTU-1B 1 kW

Part No. NPN LTU-5B 5 kW

Part No. NPN LTU-10B 10 kW

Part No. NPN LTU-25B 25 kW

TRANSMISSION LINE AND ACCESSORIES

Collins supplies a complete complement of Andrew and Cablewave transmission lines and accessories for use in flexible (foam or air dielectric) and rigid applications.

All items receive careful factory inspection by the manufacturer through continuing quality control processes. Each production length of cable is tested for pulse reflection, high voltage, leakage, and continuity. Air dielectric cables are pressure checked before shipment and shipped with dry air pressure. Lengths are normally custom cut and fittings factory attached. Standard cutting tolerance is + 2%. Closer tolerance is available on order.

If desired, coaxial cables may be phase stabilized to provide a repeating (or "stable") phase-temperature characteristic. This is obtained through factory heat treatment of the cable.

Collins can provide any item in the Andrew or Cablewave line. In addition, Collins is now able to offer the new Andrew 4 inch air dielectric Heliac line for high-power FM installation. Some of the most commonly used items include:

Flexible line (foam dielectric) in 3/8", 1/2", 7/8", and 1 5/8" sizes.

Flexible line (air dielectric) in 7/8", 1 5/8", 3", and 5" sizes.

Rigid line (50 ohm) in 1 5/8", 3 1/8", and 6" sizes.

All necessary jacks, plugs, flanges, barriers, splices, terminals, and reducers.

All necessary hangers and accessories.

Pressurizing equipment and coaxial switches.

Information on special items is available from your Collins Broadcast Sales Representative.



ANDREW RIGID



ANDREW AIR HELIAC



ANDREW FOAM HELIAC



CABLEWAVE FOAM WELLFLEX



CABLEWAVE AIR WELLFLEX



CABLEWAVE RIGID

TYPICAL INSTALLATIONS

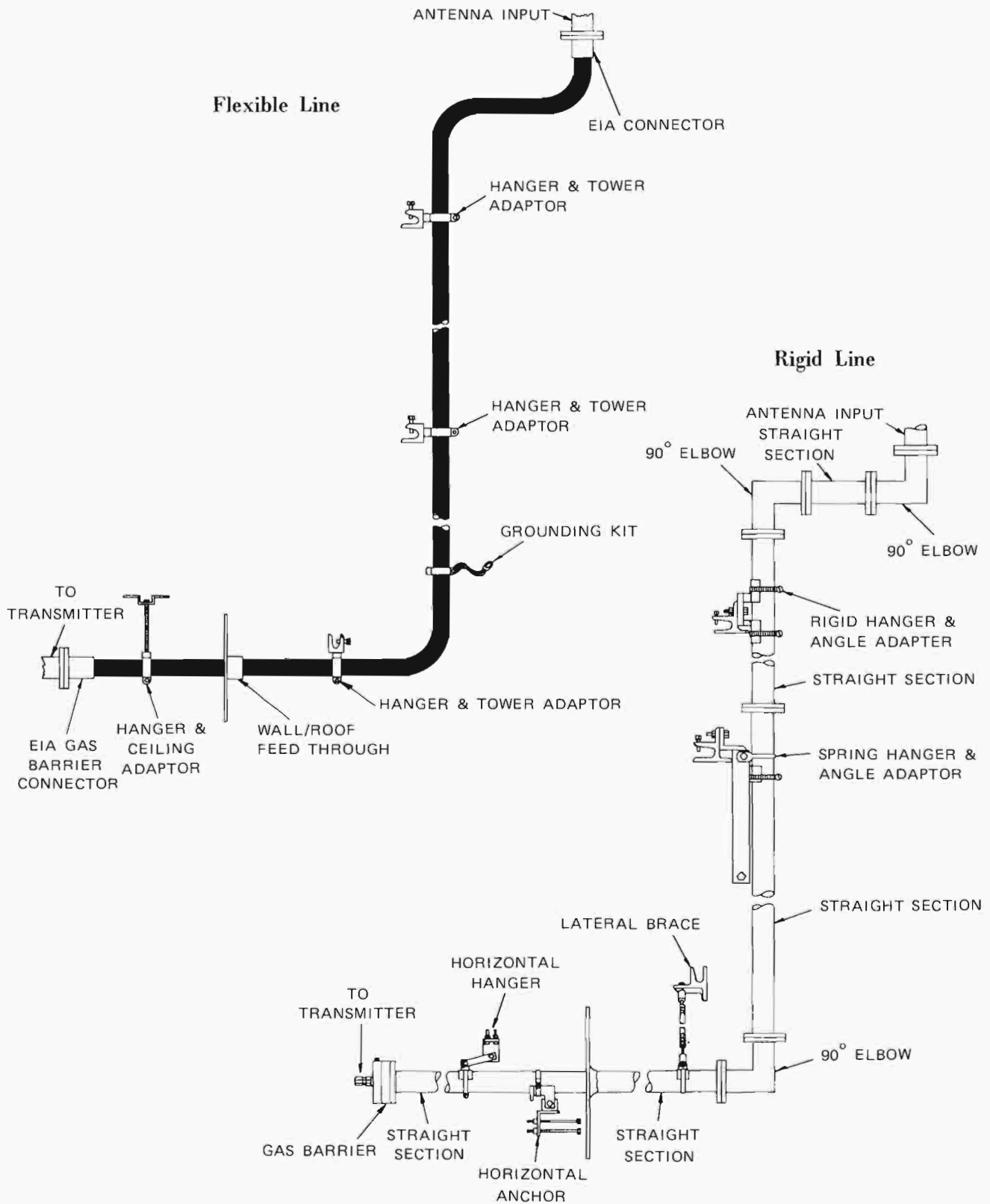



**AUDIO
and
STUDIO EQUIPMENT**

CONSOLES

Collins IC Console Series

The Collins IC-10 and IC-6 all solid state consoles offer the broadcaster versatility and custom configuration capability for practically every requirement. They may be used for AM, FM, FM stereo, and custom audio installations. Both may be configured for programming separate monaural, stereo, or dual channel monaural, simultaneously.

The IC-10 can be configured to suit customer requirements by plugging in the necessary amplifiers or transformers to provide proper matching and amplification. All controls are dual, controlling the left and right channels simultaneously. All inputs may be used for balanced or unbalanced mic level, high level balanced line, or high level equalized phono. The phono equalizer is remotely located at the turntable to eliminate RF interference.

The inputs of channels one through eight are connected to the console circuits through two position input selector switches. Channels nine and ten are connected through a pair of six-position rotary switches. These inputs may be used for either remote lines or normal inputs, either low and high level.

Besides the many features that the IC-10 offers the broadcaster in the way of performance and flexibility, human engineering has made possible a level of operator convenience that is truly remarkable. Included as part of the standard IC-10, are recessed pushbutton switches, located under each mixer, that may be used for remote starting of turntables, tape machines, or any other remountable equipment. These switches are wired through contacts on the input selector switches for further usefulness in operation. The IC-10 cabinet is of modern design, and offers ease of maintenance.

Similar in construction to the IC-10, the IC-6 is designed for the smaller AM or FM station that does not require as many inputs as the IC-10. The IC-6 incorporates all the design features and versatility of the larger unit. The IC-6, like the IC-10 may readily be expanded from monaural to stereo capability by simply adding the required plug-in amplifiers and VU meters. An additional option is a digital readout time-temperature display, mounted in the front panel.

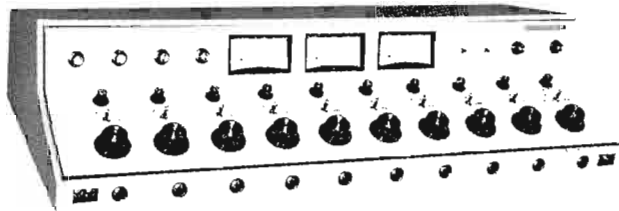

IC-10 10-Channel Console

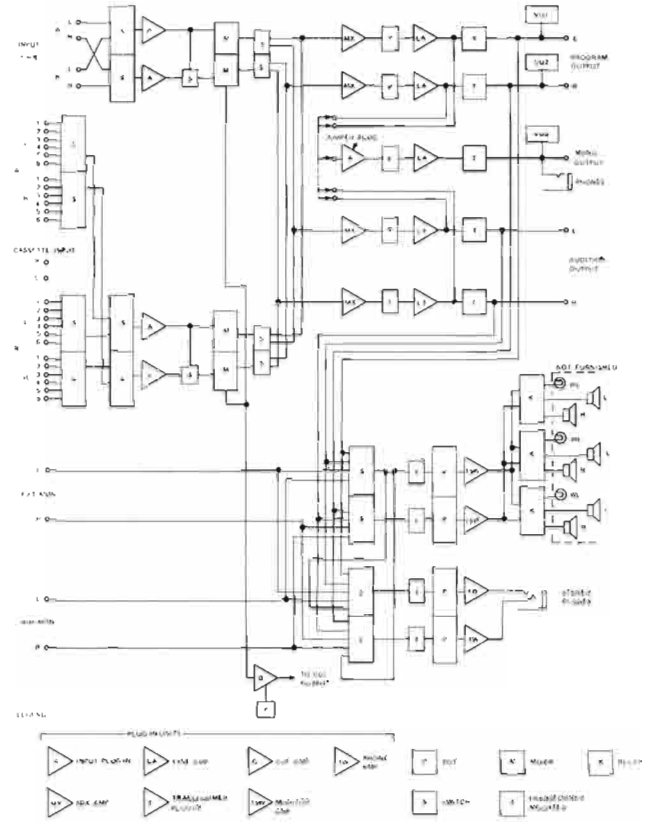

IC-10 Block Diagram

SPECIFICATIONS

POWER SOURCE

117 or 230 Vac, 50 to 60 Hz, single-phase

INPUT CHARACTERISTICS

IC-10

Eight stereo channels for use as balanced or unbalanced microphone or high-level line signals.

Two stereo channels with multiple inputs.

IC-6

Five stereo channels for use as balanced or unbalanced microphone or high-level line signals.

One stereo channel with multiple inputs.

Input Impedances

High level: 10-kilohm bridging, 600-ohm term.

Microphone: 200 ohms or 50 ohms

External monitor: 10 kilohms

Input Levels

High level: -10 dBm to +10 dBm

Microphone: -65 dBm to -50 dBm

External monitor: -10 dBm to +10 dBm

OUTPUT CHARACTERISTICS

Monaural program
Stereo program
Stereo audition
Three separate stereo monitors
Stereo headphone jack
Monaural headphone jack

Output Load Impedances

Program audition outputs:
600 ohms, balanced
Monitor outputs: 4 to 16 ohms,
unbalanced
Headphone outputs: 8 ohms to
50 kilohms

Output Levels

Program, audition outputs: +8 dBm
nominal, +24 dBm maximum
Monitor outputs: 15 watts into
8 ohms maximum

FREQUENCY RESPONSE

Program audition outputs:
 ± 1 dB, 30 Hz to 15 kHz
Monitor outputs: ± 1.5 dB,
30 Hz to 15 kHz

DISTORTION CHARACTERISTIC

Program audition outputs: less than
0.5% THD
Monitor outputs: less than 1.5% THD

EQUIVALENT INPUT NOISE

Program audition: -120 dBm
Monitor: -110 dBm

GAIN

100 dB

SERVICE CONDITION

Ambient Temperature

+15° to +40°C (60° to 100°F)

Humidity

0 to 95% relative humidity

Altitude

10,000 ft maximum

Vibration and Shock

Normal handling and shipping

DIMENSIONS

IC-10 Series

10 inches high; 25.4 cm
20 inches deep; 50.8 cm
44 inches wide; 118 cm

IC-6 Series

10 inches high; 25.4 cm
20 inches deep; 50.8 cm
36 inches wide; 91.5 cm

WEIGHT

IC-10 series, approximately
40 lb; 18.5 kg
IC-6 series, approximately
30 lb; 13.88 kg

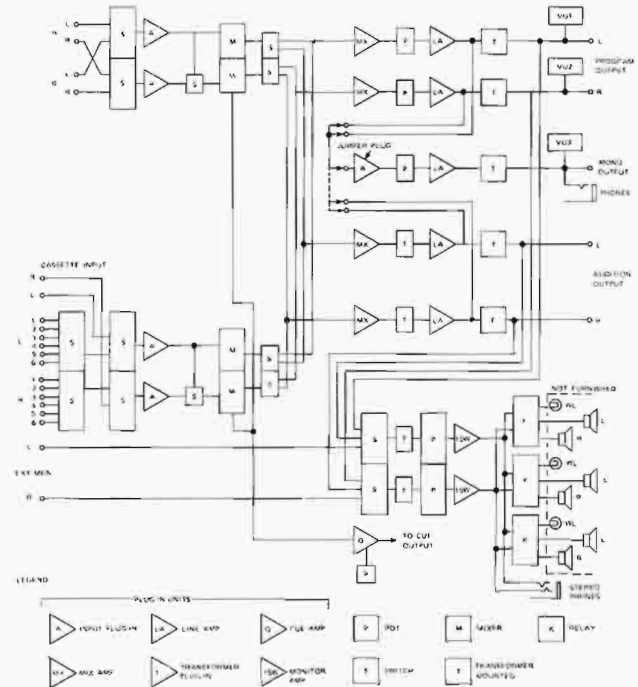

IC-6 Block Diagram

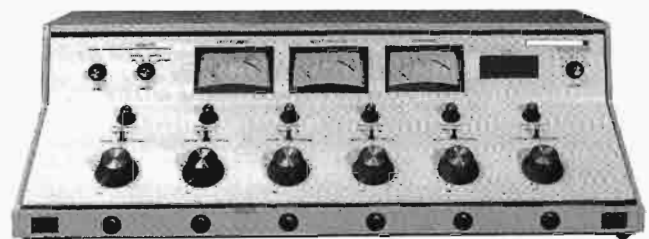

IC-6 6-Channel Console

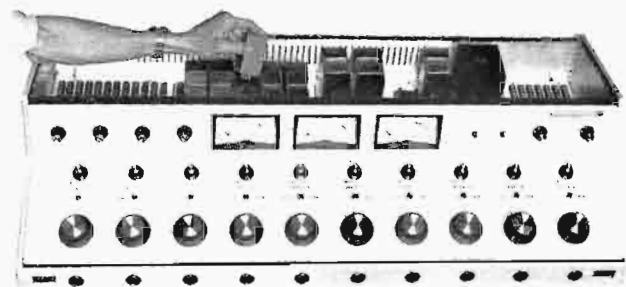

IC-10, Showing Plug-In Modules

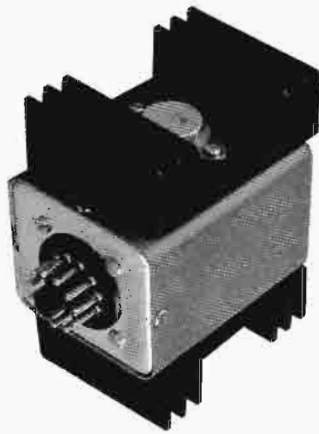

IC-6/10 Power Supply



IC-6/10 Plug-in Module

Collins 212T-1 Console

Designed especially for television, large AM facilities, and recording studios, the 212T-1 is a dual-channel console providing 28 inputs to 14 faders, two program output channels, a VU meter for each program output channel, two auxiliary program outputs, two 10-watt monitor outputs, and a built-in cueing speaker.

Each fader is engraved and has illuminated pushbuttons for A and B input selection and channel 1 or 2 selection. These buttons are the push-on, push-off type and are normally preset prior to air time. Two levels of illumination show the status of all switches during operation. The overall level is adjustable by a single control knob on the rack-mounted assembly. This feature is especially useful in dimly lighted areas, such as a TV control room.

SIZE: 15-3/4" (40 cm)H; 24" (61 cm)W; 6" (15 cm)D.

WEIGHT: Rack - 41 lbs (19 kg); panel - 32.5 lbs (15 kg).

212T-1 772-5108 Audio Console

Russco Studio/Master 505 Audio Mixer

The compact, all solid state 505, available in either rackmount or desktop configuration, is designed for AM or monaural FM broadcast applications. It has five mixing channels, four of the channels having built-in preamplifiers. Each preamp can be quickly modified to accept microphone, phono, or high level inputs. The fifth channel accepts five high level inputs, selectable by front panel pushbuttons. The model 505 features pushbutton "on air" switches with indicator lamps, a built-in 25 watt monitor amplifier, and a cue amplifier driving a built-in speaker.

INPUTS: 9 Total

Channels 1-4	(Preamps)	(Unbalanced)	
	Hi Level	Microphone**	Phono***
Sensitivity*	-13dBm	0.8mv	7mv
Max Input	+dBm	13mv	100mv
Impedance	47K	47K	47K
Channel 5	(Balanced)		

*Sensitivity: -10dBm

Max Input: +18dBm
Impedance: 600 ohms

OUTPUTS:

Monitor:

Power: 25 watts average

(14.14 volts RMS across 8 ohm load at 1 KHz)

Impedance: 8 ohms

Total Harmonic Distortion: Less than 1%
at full rated output.

Program:

Level: +4 or +8dBm, for OVU, +17dBm maximum

Impedance: 600 ohms

Frequency Response: 2Q to 15 KHz, ±1 db

Total Harmonic Distortion: Less than 0.5% at 1KHz, +8 dBm out.

Noise: Greater than 60dB below +4dBm output referenced to -50dBm input level.

Headphone: Level: 0dBm

Impedance: Hi down to 8 ohms

Cue: Power: 1 watt average

Speaker: 8 ohms, 3 inch

On-Air Light (Relay Driver)

Voltage: -24 VDC

Current: 40ma (600 ohm coil)

*Mixer Pot at 1:30 o'clock position, 0 VU out.

**Referenced to low impedance microphone source.

***At 1KHz.

CONTROLS:

*Input mixing - 5 each, with cue

*Monitor level - 1 each, with power switch, on front panel.

Master level

Cue level

Trim pot on main P.C. Board

Headphone level

**On-Air key switches (Channels 1-4) - 4 each, push-button, alternate latching, DPDT.

Input selector switches (Channel 5) - Push-button, interlocked, 5x DPDT.

P.C. Boards:

Main Board - Input and Output Amplifiers.

Pot Board - Mixing busses and booster amp.

Hi Level Board - Hi level input switch, Power indicator and VU meter leads.

P.C. Interconnections: 16 pin DIP plugs and flat cable.

SIZE: (rack 5-1/4" (13.3 cm)H; 19" (48.5 cm)W; 8" (20.3 cm)D. (desk 5-1/2" (14 cm)H; 20-1/4" (51.4 cm)W; 8" (20.3 cm)D.

WEIGHT: 14 lbs (6.4 kg)

505 NPN Audio Mixer

Power Requirements: 117 VAC, 60Hz, 100 watts

*Allen-Bradley MODSPOT, Hot-molded element, rated at 100,000 rotations

**Grayhill series 46, rated at 250,000 operations.



Studio/Master 505 Audio Mixer

TURNTABLES

Russco

Designed to meet exacting requirements of fine music stations, Russco turntables provide the broadcaster with a ruggedly constructed, highly reliable system. Two models are available: the 3-speed Cuemaster and 2-speed Studio Pro. Both feature no slip starting with full 33 rpm speed at less than 1/16th revolution, heavy duty synchronous motor, 45 rpm record indentation, platter offset for more compact turntable arrangement, solid cast aluminum chassis, and Oilite bronze bearings throughout.

Specifications

	Cue Master	Studio Pro
SPEED	33, 45, 78	33, 45
PLATTER WEIGHT	5.5 lbs (2.5 kg)	6.5 lbs (3 kg)
ACCELERATION	1/16 rev. at 33 rpm	1/16 rev at 33 rpm
WOW & FLUTTER	Less than 0.3%	Less than 0.3%
RUMBLE	36 dB below NAB level	38 dB below NAB level
SIZE	15-1/2" (39.4 cm)H; 15-1/2" (39.4 cm)W; 6-1/2" (16.5 cm) below chassis	15-1/2" (39.4 cm)H; 15-1/2" (39.4 cm)W; 7-1/2" (13 cm) below chassis
UNIT WEIGHT	16 lbs (7.3 kg)	20 lbs (9 kg)
Cue-Master	NPN	Turntable
Studio-Pro	NPN	Turntable



Russco Studio-Pro Turntable

Panasonic Technics

For broadcasters requiring exceptionally high fidelity in audio systems, three models of Technics turntables are available: SP-10, SL-1100A, and SL-1200. All three employ a brushless dc direct drive motor providing table speed constancy of 33.29 rpm to 33.36 rpm. "Fine tuning" of table speed is effected by electronic control. All three tables operate at both 33 and 45 rpm. The SP-10 is table only, the SL-1100A and SL-1200 are supplied with precision tone arms. Wow, flutter, and rumble effects all but disappear in these models; rumble is better than -70 dB (Din B) and wow and flutter is less than 0.03% WRMS. Turntable acceleration time is less than 1/2 revolution at 33 rpm speed.

Specifications

PLATTER SIZE	SP10	SL-1100A	SL-1200
	12"	13 25/32"	13"
PLATTER WEIGHT	6 lb (2.7 kg)	4.4 lb(2 kg)	3.86 lb (1.7 kg)
TONEARM TYPE	—	Static-balanced tubular	Static-balanced tubular
TRACKING FORCE	—	0-5 gr	0-4 gr
TRACKING ERROR ANGLE	—	Within ±1.75°	Within ±2°
SIZE	4" (10.2 cm)H;	7 11/16" (19.5 cm)H;	7 3/32" (18 cm)H;
	14" (35.6 cm)W;	20 3/32" (51 cm)W;	16 9/32" (41.3 cm)W;
	14" (35.6 cm)D.	15 3/8" (39 cm)D.	13 29/32" (35.3 cm)D.
SP-10	NPN	Turntable	
SL-1100A	NPN	Turntable w/Tone Arm	
SL-1200	NPN	Turntable w/Tone Arm	

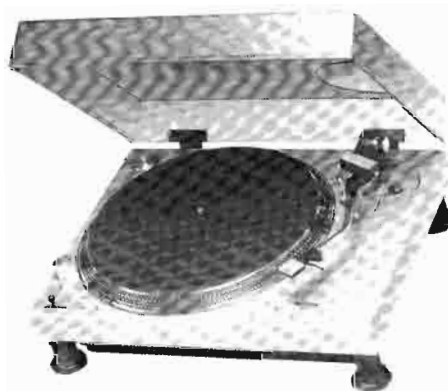

Technics SL-1200 Turntable

TONE ARMS

Micro-Trak 303/306

Modern styling and plug-in memory balance head highlight the Russco Micro-Trak tone arms. Laminated wood and epoxy body contribute to both lightness and strength. Stylus force, once set, is temperproof, and adjusted by counterweight. Model 303 is 12 inches; Model 306 is 16 inches.

303	NPN	12" Tone Arm
306	NPN	16" Tone Arm

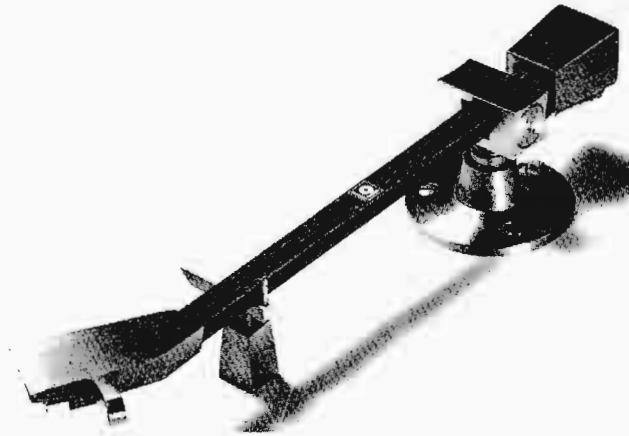

Micro-Trak 303 Tone Arm

Russco RA-12 Tone Arm

The Russco RA-12 tone arm has all the features demanded by the broadcaster. It is made of machined aluminum and steel with a high-impact plastic pivot post support. It has a high-accuracy direct reading stylus pressure control and an anti-skating compensator that allows precise adjustment of stylus side pressure. This centers the stylus and minimizes record drag and wear. All adjustments, including tone arm height, are made without special tools. The cable has standard phono plugs for stereo or monaural operation; the head accepts all American and foreign cartridges.

RA-12	NPN	12" Tone Arm
-------	-----	--------------

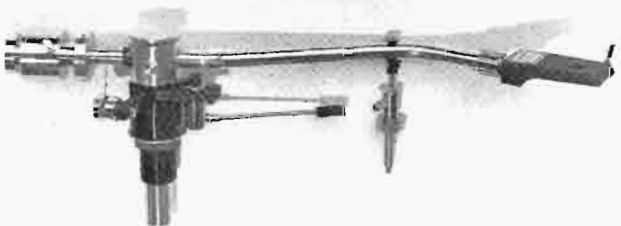

Russco RA-12 Tone Arm

Shure M232 Tone Arm

A rugged, simple arm for tracking at 1-1/2 grams or higher, the M232 has a full range of adjustments for static and dynamic balance, cartridge overhang, height, and direct reading force scale. It accommodates any stereo or mono cartridge. The M232 is designed for 12-inch tables; for 16-inch tables, the M236 should be specified. An ideal cartridge for professional applications is the M44-7. It has a spherical stylus with a medium tracking force (1-1/2-3 grams). It is 0.0007" in size.

M232	NPN	12" Tone Arm
M236	NPN	16" Tone Arm
M44-7	NPN	Stereo Cartridge w/stylus



Shure M232 Tone Arm

Stanton Cartridges

Stanton offers a complete line of cartridges and styli for the most exacting broadcast and audio applications. All Stanton cartridges are designed for use with all 2- and 4-channel matrix-derived compatible systems. The 600 HP Series features reduced tip mass for outstanding frequency response and can stand rugged handling encountered in on-the-air use. They are available in both spherical and elliptical stylus point models. The 500 series is available in several configurations depending on application: auditioning up to ultra high reproduction of fine music.

600 ()	NPN	HP Series Cartridges
500 ()	NPN	Broadcast Series Cartridges



Stanton 600 Cartridge



Stanton 500 Cartridge

TURNTABLE ACCESSORIES

Collins PA-1 Phono Preamplifier/Equalizer

The PA-1 Phono Preamplifier/Equalizer plugs into the PMA-1 Mount which in turn fits into a turntable cabinet. The PMA-1 accepts two of these units for stereo operation. The PA-1 receives power from either the LC-6 or IC-10 Stereo Console. When using a PA-1, a type MT-1 600/600 ohm matching transformer is installed in the IC console in lieu of the usual MPA-1 Microphone Preamplifier. Frequency response of the PA-1 is 50 Hz to 15 kHz, ± 1 dB of RIAA curve; output impedance is 600 ohms; input is low impedance.

PA-1 NPN Phono Preamplifier/Equalizer

Russco Phono Preamplifiers

Two series are available: the Fidelity-Master Series for straight RIAA equalization, and the Fidelity-Pro Series with switchable high and low frequency filters. Both feature integrated circuit construction, built-in power supplies and easy access to all components for maintenance and testing. Each is available in four models: unbalanced monaural output, balanced monaural output, unbalanced stereo output, and balanced stereo output. Frequency response is 20 Hz to 20 kHz, ± 1 dB of RIAA curve; noise is 65 dB below NAB reference level; output is +18 dBm into 600 ohm load; input impedance is 47,000 ohms; power requirement is 40 milliwatts at 117 volts ac, 60 Hz.

SIZE: 1-3/4" (4.4 cm)H; 4-3/4" (12 cm)W; 11" (27.9 cm)D.

WEIGHT: 4 lbs (1.8 kg) maximum (depending on model).

FM () NPN Phono Equalizer

FP () NPN Phono Equalizer w/filter switching.



Russco Phono Preamplifier

Micro-Trak Series L Turntable Furniture

Modular in design and human-engineered, the Micro-Trak Series L furniture provides functional workspace for the studio engineer or disc jockey. Turntables, tape machines, cueing, and switching control panels all may be located within easy reach of the operator. Side panels are finished in pecan Formica with tops in an attractive gold Formica. Construction features include: standard EIA equipment mounting configuration for standard 19-inch panels; factory-made turntable cutouts; replaceable tops, sides, spreaders, and closure panels, and full 3/4" particle board construction for low accoustical transfer. Items in the series include a single-bay cabinet, a double-bay cabinet, and a console table surface.

SIZE: (single-bay cabinet) 29" (73.7 cm)H; 22" (55.9 cm)W; 22" (55.9 cm)D.

(double-bay cabinet) 29" (73.7 cm)H; 41-3/4" (106 cm)W; 22" (55.9 cm)D.

(Console surface 80" (203.2 cm)W; 24" (61 cm)D.

WEIGHT: (single-bay cabinet) 66 lbs (29.9 kg)

(double-bay cabinet) 117 lbs (53 kg)



Micro-Trak Series L. Turntable Furniture

LIMITERS AND AMPLIFIERS

COLLINS 26U-3 PEAK LIMITING AMPLIFIER

The basic purpose of the 26U-3 is to ensure that peak signals are attenuated sufficiently to prevent over-modulation at the transmitter output. Some "soft" means of accomplishing this is desirable to keep distortion due to clipping to a minimum, and yet keep the overall signal level as high as possible. This has been accomplished by utilizing optimum attack and release times of the agc signal.

In the limiting amplifier, symmetrical or unsymmetrical clipping is controlled "behind-the-panel" to prevent inadvertent adjustment. Manual controls engage preemphasis and deemphasis networks for FM transmitter installations. The 26U-3 provides a truly balanced 600-ohm input and will provide either 600- or 150-ohm operation.

Frequency Response: 50 Hz to 15 kHz

Total Distortion: Less than 1% at maximum output and all compression levels

Automatic Gain Control Range: 10 db dynamic range, minimum

Compression Ratio: 10:1 minimum

Normal Input/Output Levels: 10 dbm

Maximum Output Level: 20 dbm

Attack Time: 2 microseconds

Release Time: 150 milliseconds

Input Impedance: Fully balanced, 600 ohms

Output Impedance Dual floating 150-ohm secondaries for any 600- or 150-ohm connection

Size: 5-1/4" (13.3 cm)H; 19" 48.5 cm)W; 15-3/4" (40 cm)D.

Weight: 15 lbs (6.8 kg)

26U-3 758 5778 001 Peak Limiting Amplifier

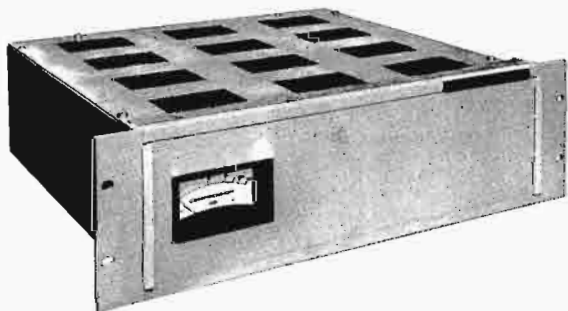

Collins 26U-3 Peak Limiting Amplifier

Collins 26J-3 Auto-Level Compression Amplifier

With the 26J-3 Compression Amplifier, a broadcaster is afforded automatic level control of program material. This compact unit, which provides either 600- or 150-ohm operation in either AM or FM installations, has 10 db more

automatic gain control range than comparable models. It can be operated in pairs to achieve stereo broadcasting.

This compression amplifier incorporates the latest solid-state techniques, including maximum use of linear integrated circuits for increased reliability and lower power dissipation. A balanced H-pad network with 600-ohm impedance provides a truly balanced 600-ohm load for operation from a balanced or unbalanced source.

Frequency Response: 50 Hz to 15 kHz, flat within 1 dB

Total Distortion: Less than 1% at maximum output and all compression levels

Automatic Gain Control Range: 30 db dynamic range, minimum

Compression Ratio: 15:1 minimum

Normal Input/Output Level: 10 db

Maximum Output Level: 20 db

Attack Time: 5 milliseconds

Release Time: 9 seconds

Input Impedance: Fully balanced, 600 ohms

Output Impedance: Dual floating 150-ohm secondaries for any 600 or 150-ohm connection.

Automatic Gain Control Threshold: 20 db below normal input

Gain Below Threshold: Automatically returns to nominal gain after extended signal pause

Size: 5-1/4" (13.3 cm)H; 19" (48.5 cm)W; 15-3/4" (40 cm)D.

Weight: 15 lbs (6.8 kg)

26J-3 758 5776 001 Auto-Level Compression Limiter

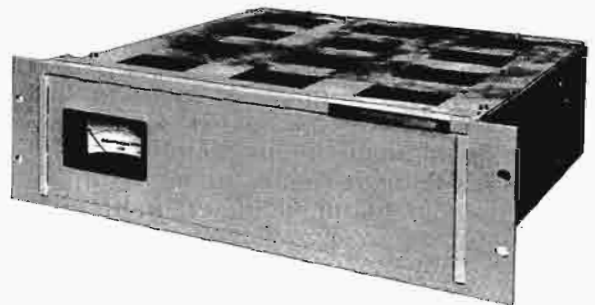

Collins 26J-3 Auto-Level Compression Amplifier

CBS FM Limiting Amplifiers

This family of units provides the FM broadcaster with an effectiveness means to prevent overmodulation caused by pre-emphasized signals, prevent SCA crosstalk, achieve higher modulation levels without distortion, and maintain automatic level control. The Model 4100 automatic peak controller processes low, middle, and high frequencies independently; overall instantaneous limiting assures no overmodulation will occur. Frequency response is flat ± 1 dB below the limiting threshold; harmonic distortion is less than 1%; attack time is less than 1 microsecond (depending on wave form); and recovery time varies between 200

milliseconds and 1 microsecond (depending on frequency). Model 4110 is similar in all respects, except that it is configured for stereo operation. Model 4450A automatic level control automatically rides gain and features an expanded return-to-zero function. Recovery time is adjustable for optimum compatibility with program format. Its control characteristic is ± 10 dB of gain control; maximum gain is 40 dB.

SIZE: (4100 & 4110) 1-3/4" (4.4 cm)H; 19" (48.5 cm)W; 18-3/4" (47.6 cm)D.

WEIGHT: (4100) 13 lbs (5.9 kg)
(4110) 14 lbs (6.4 kg)

SIZE: (4450A) 1-3/4" (4.4 cm)H; 19" (48.5 cm); 16" (40.6 cm)D.

- 4100 NPN Peak Level Controller
- 4110 NPN Stereo Peak Level Controller
- 4450A NPN Stereo Automatic Level Control

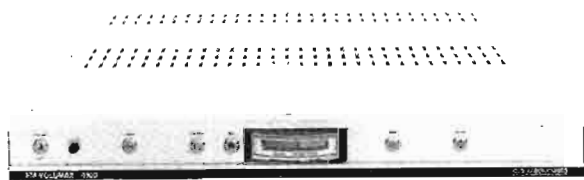

CBS 4100 Limiter



CBS 4450A Limiter

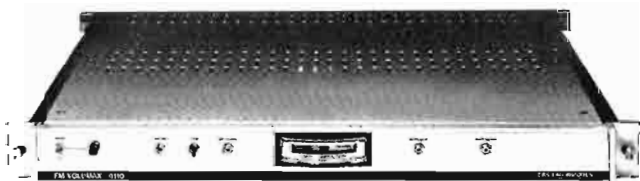

CBS 4110 Limiter

CBS AM Limiting Amplifiers

For the AM broadcaster, CBS provides a complete line of limiters, equalizers, level controllers, and distribution amplifiers. The Model 4000 automatic peak controller provides control of speech asymmetry: it ensures that the highest amplitude peaks always positively modulate the transmitter. Silent polarity switching occurs during the split-second pauses in a speech program with no obtrusive clicks. Negative peaks are controlled at 24 dBm; positive

peaks at 24, 25.5 or 30 dBm. The companion automatic level control for this unit is the Model 4440. It is essentially the monaural version of the 4450A described previously.

SIZE: 1-3/4" (4.4 cm)H; 19" (48.5 cm)W; 14-1/2" (36.8 cm)D.

4000 NPN Automatic Peak Controller



CBS 4000A Limiter

CBS 4500 Dynamic Presence Equalizer

Model 4500 is designed to increase amplitude of the presence band (2 to 4 kHz) to overcome poor microphone technique, incorrect equalization, or excessive tape recording levels. Use of the speech-music discriminator module is optional and permits enhancing just speech, all programming, or removing control completely. The 4500 has a response of maximum boost to 10 dB at 3.4 kHz, or flat (with no control) within 0.5 dB, 50 to 15,000 Hz. Input level is 0 to 23 dBm; maximum peak output level is 24 dBm; maximum gain is 19 dB.

SIZE: 1-3/4" (4.4 cm)H; 19" (48.5 cm)W; 15" (38.1 cm)D.

4500 NPN Dynamic Presence Equalizer



CBS 4500 Equalizer

CBS 1602 Distribution Amplifier

This dual-channel unit has two balanced bridging inputs rated at 15,000 ohms each. The 8 outputs are wired for 600 ohms, but each is field-convertible by changing two resistors. Input/output connection are on the rear panel; output jacks are located on the front panel for setup convenience. Both sections of the amplifier are delay-compensated to 3° at 15 kHz for stereo operation. Response is ± 0.5 dB, 20 Hz to 20 kHz; nominal gain is 20 dB, maximum gain is 40 dB.

SIZE: 1-3/4" (4.4 cm)H; 19" (48.5 cm)W; 9" (22.9 cm)D.

WEIGHT: 3 lbs (1.4 kg)

1602 NPN Distribution Amplifier



CBS 1602 Distribution Amplifier

CBS 710 Automatic Loudness Controller

The Model 710 is designed to reduce those portions of the audio signal which may sound excessively loud. The loudness analyzer portion of the circuit compares the signal to an ear sensitivity characteristic. If the signal does not exceed the pre-determined threshold, the system operates as a unity gain amplifier. If the threshold is exceeded, the analyzer suppresses the offending portion of the spectrum until the passage is over. Attack time is 100 milliseconds; recovery time is 2.5 seconds. Maximum peak output level is + 25 dBm; gain is 0 to -6 dB, automatically variable. For stereo operation, Model 711 is used, consisting of two Model 710 units strapped and mounted together.

SIZE: 3-1/2" (8.9 cm)H; 19" (48.5 cm)W; 9-5/8" (24.4 cm)D.

WEIGHT: 18 lbs (8.2 kg).

710 NPN Automatic Loudness Controller.

CBS/Sony SQE-2000 Quad Encoder/Mixer

The CBS/Sony Encoder/Mixer provides the broadcaster or producer with full quadraphonic production capability. While not required to broadcast 4-channel records, the unit does provide capability to broadcast 4-channel tapes, and permits local production of 4-channel programs. The SQE-2000 produces signals completely compatible with all stereo and mono receivers and matched to practically every type of decoder offered for home receivers. The unit features accurate phase characteristic and frequency response; basic SQ encoding plus interior-, forward-, and back-oriented encoding for special quadraphonic effect; four line inputs for broadcasting 4-channel tapes; four low-impedance mike jacks; stereo mixing through double 4-channel linear potentiometers; stereo headphone monitoring; and optional 12 volt power supply for remote pickup applications.

SIZE: 6-1/8" (15.5 cm)H; 15-3/4" (40 cm)W; 12-5/8" (32 cm)D.

WEIGHT: 16.6 lbs (7.5 kg).

SQE-2000 NPN Quad Encoder/Mixer

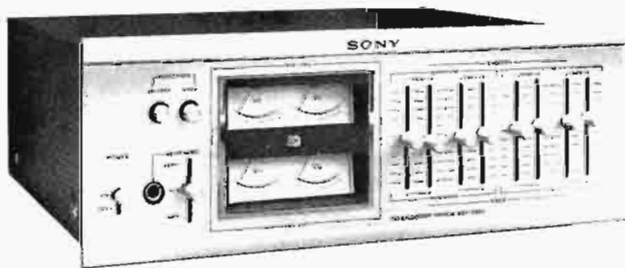

CBS/Sony Quad Encoder

Crown Stereo Audio Amplifiers

The Crown series of stereo amplifiers are ideal where exceptionally high fidelity is required. The all solid state systems are designed and engineered to handle all types of loads, including electrostatic speaker systems. They also may be used as add-on units for quadraphonic installations. Model D-60, a 60-watt unit has power response of ± 1 dB 5 Hz to 30 kHz at 30 watts, both channels. Frequency response is ± 0.1 dB, 20 Hz to 20 kHz; total harmonic distortion is less than 0.05% at 30 watts. The D-150 model is rated at 75 watts per channel. Its characteristics are similar to the D-60. For larger applications, the DC-300A model is available with a rating of 150 watts per channel. It has similar characteristics to the D-60 model. An optional rack-mounting kit is available as are oiled walnut enclosures.

SIZE: (D-60) 1-3/4" (4.4 cm)H; 17" (43.2 cm)W; 8-3/4" (22.1 cm)D.

(D-150) 5-1/4" (13.3 cm)H; 17" (43.2 cm)W; 9" (22.9 cm)D.

(DC-300A) 7" (17.8 cm)H; 19" (48.5 cm)W; 9-3/4" (24.8 cm)D.

D-60 NPN Stereo Audio Amplifier, 60 watts.

D-150 NPN Stereo Audio Amplifier, 150 watts.

DC-300A NPN Stereo Audio Amplifier, 300 watts.



Crown D-60 Stereo Amplifier



Crown D-150 Stereo Amplifier

Spectra Sonics 610 Complimeter (tm)

This unit performs the functions of peak limiting and volume compression either independently or simultaneously. Extremely low noise characteristics provide a very low threshold of -40 dBm, allowing the greatest input sensitivity and compatibility with audio equipment used in recording and broadcasting applications. Attack time is automatically variable: the limiting function – 100 nanoseconds to 2 microseconds; the compression function – 100 nanoseconds to 1.2 milliseconds. Frequency response is ± 0.5 dB, 20 Hz to 20 kHz at 16 dBm; harmonic distortion is less than 0.1%, 30 Hz to 20 kHz, up to 30 dB compression. An optional accessory permits coupling two units together for stereo operation.

SIZE: 3-1/2" (8.9 cm)H; 19" (48.5 cm)W; 8-1/2" (21.6 cm)D.

WEIGHT: 9.5 lbs (4.3 kg)



Spectra Sonics Complimeter (TM)

CARTRIDGE TAPE SYSTEMS

ITC RP Series Recorder/Reproducer

This compact recorder/reproducer, available in several models and with several options, includes the most-wanted features for the broadcast industry. The RP models accept NAB cartridges A, B, and C (2 seconds to 31 minutes with 1 mil lubricated tape at 7-1/2 ips. Start and stop time is 0.1 second. Tape speed is 7-1/2 ips with other speeds available on special order. Wow and flutter is 0.2% rms or less; noise is 55 dB or better below reference of 400 Hz; distortion is 2% or less at 0 VU record level. The capstan is directly driven by a hysteresis synchronous motor. Optional auxiliary cue tone oscillators permit secondary and tertiary tones to be added during recording or playback. Another option is a high-speed (30 ips) tape advance to the next cue tone. The models come in either monophonic or stereophonic configurations; with or without secondary and tertiary cues, and with or without high-speed tape advance.

SIZE: 5-1/4" (13.3 cm) H;
17-1/2" (44.4 cm) W;
11" (27.9 cm) D.

WEIGHT: 39 lbs (17.7 kg)

RP-() NPN Recorder/Reproducer

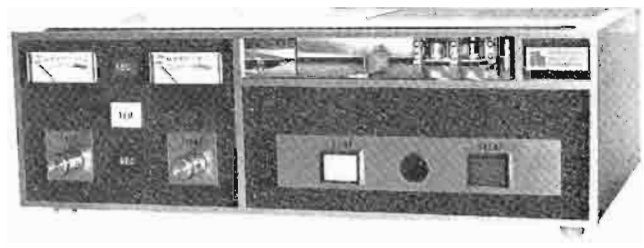

ITC RP Recorder

ITC Reproducers

Compact, flexible, and highly versatile, the ITC 3D series of reproducers can perform a variety of functions. The three decks may be operated simultaneously or independently and may be fed to separate consoles or a single console, according to programming format. The unit accepts both NAB A and B cartridges. Automated breaks may be set up through use of the optional 150 Hz (secondary) cue. Physical size permits mounting a pair of these units in a standard 19-inch rack if desired. The addition of the WRA Recording Amplifier makes the unit a complete recorder/reproducer system. Four models are available: monophonic, stereophonic, mono with cue oscillators, stereo with cue oscillators. All indicators and controls may be remoted with the exception of the meter switch. A single-play reproducer also is available for less demanding installations.

SIZE: 5-1/4" (13.3 cm) H;
8-1/2" (21.6 cm) W;
11" (27.9 cm) D.

WEIGHT: 12 lbs (5.4 kg).

30D-() NPN Reproducer.



ITC 3D Reproducer

SMC Record/Playback Systems

Ease of service, up-front controls, and many features make SMC systems ideal for broadcast applications. All electronics are plug-ins, making conversion from mono to stereo operation a simple step. Capstan drive is by a hysteresis synchronous motor. The record unit features 1 kHz and 150 Hz cue tones; external control tone input for logging encoding; full metering of record, play, and bias; and complete remote control connections. The unit accepts all three NAB cartridge sizes. The companion playback unit has similar design and electronic features. The units may be stacked and strapped for multiple operation. Switching functions are all solid state.

SIZE:	(each unit)	6" (15.2 cm) H; 15" (38.1 cm) W; 14" (35.6 cm) D.
WEIGHT:	(each unit)	30 lbs (13.6 kg)
790D/R	NPN	Mono Record/Playback
792D/R	NPN	Stereo Record/Playback
710D/R	NPN	Mono Playback Unit
712D/R	NPN	Stereo Playback

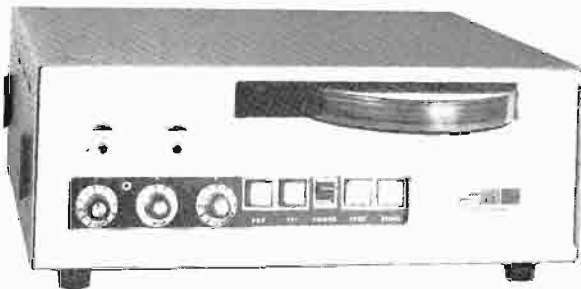

SMC Recorder

Fidelipac Tape Cartridges

These cartridges are loaded with fine quality, specially lubricated tape ideal for automatic programming equipment. The 300 series consists of loaded cartridges packed six to the box in the following lengths: 40, 70, 90, 100 seconds, 2-1/2, 3, 3-1/2, 5, 7, 7-1/2, 10, 10-1/2 minutes. The 600 series consists of loaded cartridges packed two to the box in the following lengths: 11, 12-1/2, 15, and 16 minutes. A complete complement of blank (empty) cartridges is available for the broadcaster wishing to do his own loading. Bulk tape is available in 1700-foot lengths on 7-inch reels.

300	NPN	Tape Cartridge
600	NPN	Tape Cartridge

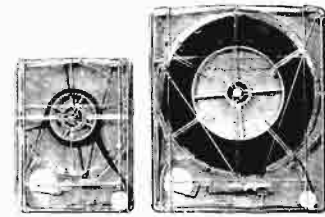

Fidelipac 300 Fidelipac 600

Aristocart Cartridges

These tape cartridges are ideal for stereo broadcasting. A unique method of tape routing in the cartridge assures perfect alignment with the reproducer heads. This minimizes distortion and enhances frequency response. Cartridges may be ordered empty, or in the following lengths: 40, 70, 90, and 100 seconds; 2½, 3½, 5½, and 8 minutes.



Aristocart Cartridge

Robins ST-500 Bulk Splicing Tape

Robins splicing tape for use with automatic programming equipment and reel to reel recording tape. 1/2 by 100-inch Mylar tape.

ST-500 124-0032-544 Bulk Splicing Tape

Robins TS-8D Splicer-Cutter

Used for magnetic recording tape, this unit cuts two rounded indentations in the tape splice, giving the splice a "Gibson Girl" shape and leaving the edges of the tape free of adhesive. The unit can be removed from its base and mounted directly on any tape recorder. It comes complete with a roll of splicing tape and tape feed.

TS-8D 124-0032-178 Splicer/Cutter.

Replacement Pressure Pads

Long lived Polyurethane pad interchangeable with pads in original cartridge in boxes of 50.

NTN 094-2546-00 Pressure Pads.

Magneraser 200C Tape Eraser

A compact and convenient bulk tape eraser that removes recorded signals from tape up to 35 mm in size and lowers background noise level up to 6 dB below that of unused tape. A pushbutton safety switch prevents current from being applied when not in use.

SIZE: 2" (5 cm) H;
4" (10 cm) diameter.

WEIGHT: 2.5 lbs (1.1 kg)

200C 097-5172-000 Tape Eraser

Audiolab TD-1 Tape Eraser

This tape eraser is designed for heavy-duty service in recording and broadcast applications. It provides a strong magnetic field to ensure complete erasure of tape cartridges and all audio, video, and computer tapes up to 10.5 inches in diameter and 1 inches in width.

SIZE: 3" (7.6 cm) H;
5-1/4" (13.3 cm) W;
7-1/4" (18.4 cm) D.

WEIGHT: 9.5 lbs (4.3 kg)

TD-1 NPN Tape Eraser

Micro-Trak Cartridge Cabinets

Designed to meet studio decor, two cartridge racks are available: a lazy susan type and a wall or console rack. The former is a substantial rotary rack which will hold 72 cartridges. It is finished in summer pecan Formica with black and white trim. The latter, designed to mount on a wall or on the console table, will accommodate 90 cartridges. It, too, is finished in pecan Formica.

SIZE: (lazy susan) 22" (55.9 cm) H;
10-1/2" (26.7 cm) W;
10-1/2" (26.7 cm) D.

(wall unit) 22" (55.9 cm) H;
23" (58.4 cm) W.

L-72-S NPN Lazy Susan Cartridge Rack
L-90 NPN Wall-Mount Cartridge Rack

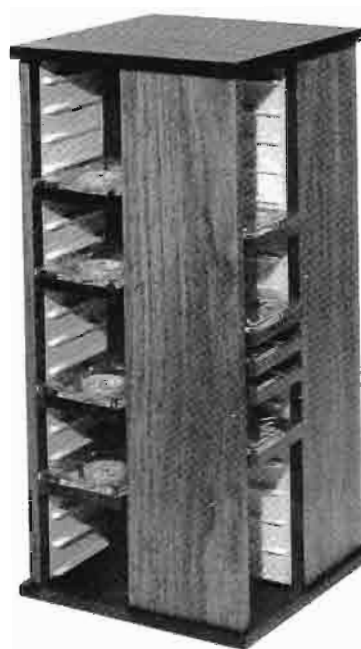

Microtrak L-72-S Cartridge Rack

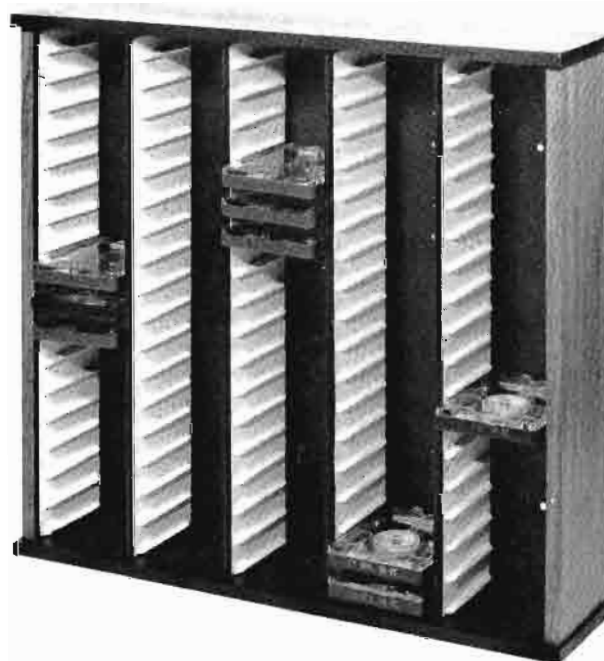

Micro-Trak L-90W Cartridge Rack

Abco Lazy Susan Cartridge Rack

This sturdy rack holds 500 of the Series 300 automatic programming equipment tape cartridges. Ten chrome-plated racks with 50 slots each make storage and selection of cartridges fast and simple. Revolves easily on roller bearing hub and will not tip regardless of arrangement of cartridges. Cartridges held in wire holders at an angle to prevent slipping out while the rack is being revolved. Shipped knocked down.

SIZE: 72" (183 cm) H;
36" (91 cm) Diameter

WEIGHT: 50 lbs (23 kg)

NTN 097-7559-000 Cartridge Rack

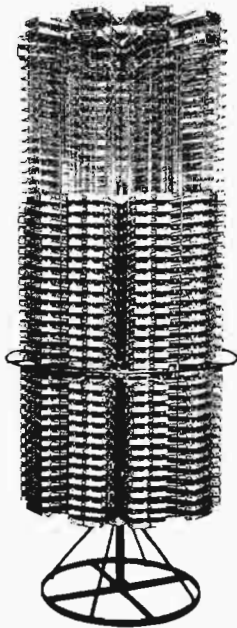

Abco Lazy Susan Cartridge Rack

REEL-TO-REEL TAPE SYSTEMS

Ampex 440 Series Recorders/Reproducers

This studio-quiet series of equipment is engineered to a degree of quiet operation that permits its use in a "live" studio. It is available in a variety of configurations: full track, two track, or four track; speeds of 7-1/2 and 15 ips or 3-3/4 and 7-1/2 ips; as a full recorder/reproducer or as a reproducer only. The units may be converted between 1/4-inch and 1/2-inch tapes with ease. The tape transport guides simply rotate to accept either tape width. The units are available in console, portable or rack-mounted configurations. They will accept up to 10-1/2-inch reels and are adjustable to accept 11-1/2-inch reels. Frequency response

is ± 2 dB, 30 – 18,000 Hz (15 ips); flutter is below 0.08% rms (15 ips); distortion is less than 0.4% (500 Hz at peak record level). For extreme technical versatility, the system may be converted to an eight-track, 1-inch tape version.

SIZE: (single-channel) 40-1/2" (102.9 cm) H;
24-1/2" (62.2 cm) W;
27-1/2" (69.8 cm) D.
(Add 3-1/2" (8.9 cm) to height for each additional channel.)

440() NPN Recorder/Reproducer



Ampex AG-440B Recorder/Reproducer

Electro Sound ES-505 Stereo

The newly-designed ES-505 is engineered for the exacting requirements of broadcasters and professional recording studios. Some of the unique features include a disappearing head gate to facilitate cleaning and degaussing; a test oscillator supplying all needed frequencies for alignment and maintenance; motion sensing system permitting shift from Fast Forward or Rewind directly into Play; bias indicator light; an optional powered third reel to take up edited tape; and a non-slip capstan. Tape speeds are 7-1/2 and 15 ips or 3-3/4 and 7-1/2 ips with automatic equalization switching; reel size is up to 10-1/2 inches with larger reels on special order. Frequency response is ± 2 dB, 30 – 18,000 Hz (15 ips); wow and flutter is below 0.06%

rms (15 ips); and distortion is less than 0.4% (500 Hz at peak record level). The unit will accept either 1/4-inch or 1/2-inch tape and is available in either full track, two track, or four track configurations.

SIZE: 44" (118.8 cm) H;
24-3/4" (62.9 cm) W;
28" (71.1 cm) D.

ES-505 NPN Recorder/Reproducer

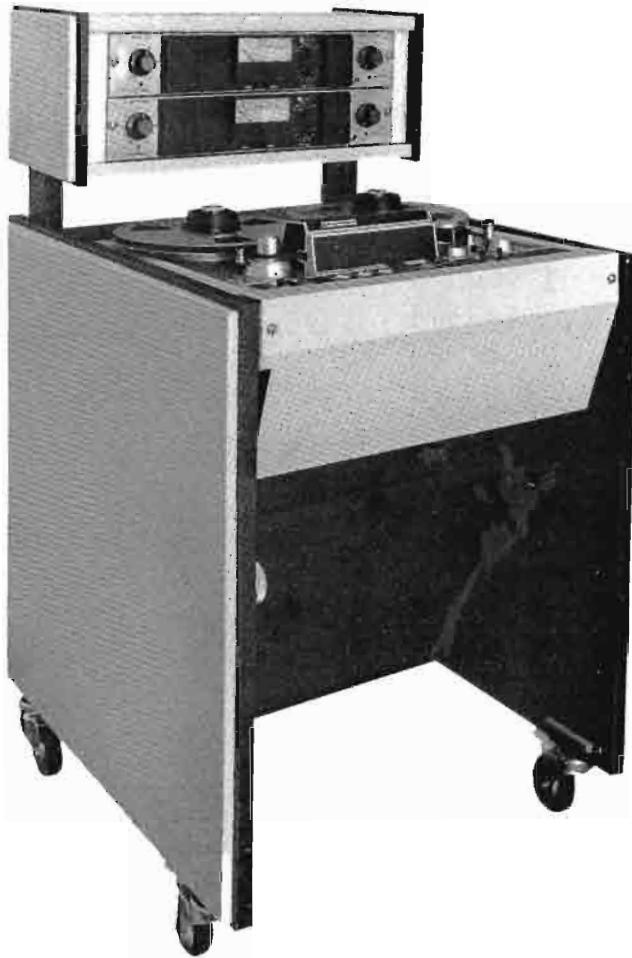

Electro-Sound ES-505 Recorder/Reproducer

Revox A77 MK III Recorder

For the broadcast requiring a versatile, ultra high fidelity recorder, the A77 MK III offers many distinct advantages. Wow and flutter is less than 0.04% total rms at 7-1/2 ips; frequency response is 2 dB, 30 – 20,000 Hz at 7-1/2 ips. Distortion is less than 2% (1 kHz at peak record level). An electronically regulated capstan motor keeps tape speed (either 7-1/2 ips or 3-3/4 ips) within 0.2% deviation. Up-front controls permit "instinctive" operation. A three-head design permits on/off tape monitoring as well as

provision for mixing, multi-track, or echo effects. There are dual inputs for front or rear microphone connection plus switchable choice of either high or low impedance. All functions can be controlled remotely (optional). The unit is easily carried from place to place and may be operated either vertically or horizontally. A specialized version is available which contains Dolby circuitry for the ultimate in noise reduction.

SIZE: 20-5/8" (52.4 cm) H;
15" (38.1 cm) W;
8-3/4" (22.2 cm) D.

A77 MK III NPN Recorder



Revox A77 Recorder/Reproducer

Scully/Metrotech 280 Series Recorder/Reproducer

The Scully/Metrotech series of recorders/reproducers offers the broadcaster an efficient, reliable, and versatile means of tape production. The units come in rack, console, or portable versions. They will accept either 1/4-inch or 1/2-inch tape with up to four-channel capacity. Tape speeds are 3-3/4 – 7-1/2 ips and 7-1/2 – 15 ips with other speeds available on special order. They will accommodate up to 11-inch reels with an option on certain models for 14-inch reels. All functions may be remoted (option) and all usual alignment controls are mounted up front. Frequency response is ±2 dB, 30 to 15,000 Hz (15 ips); flutter and wow at 15 ips is 0.08% rms or better. Innovative features include motion sensing system, an edit function permitting

tape to move without winding on the takeup reel, and optional selective synchronization for multichannel over dub effects.

SIZE: (console unit) 50" (127 cm) H;
24-13/16" (63 cm) W;
28-1/2" (72.6 cm) D.

280() NPN Recorder/Reproducer



Scully/Metrotech 280B Recorder/Reproducer

3M Bulk Tape

Collins supplies a complete line of 3M brand recording tape for reel-to-reel recorders/reproducers. Item 206 is high output/low noise tape providing 30 minutes in one direction at 7-1/2 ips. Item 211 is low noise/high dynamic tape providing 30 minutes in one direction at 7-1/2 ips. Item 213 is the same as 211, except that it provides 60 minutes in one direction at 7-1/2 ips. Item 228 is a low noise, economical tape providing 30 minutes in one direction at 7-1/2 ips.

MICROPHONES AND ACCESSORIES

Collins Microphones

The Collins series of microphones fit every application normally encountered by broadcasters. These mikes are high-quality, durable instruments with the versatility demanded by both broadcast and recording personnel. The M-21 lavalier microphone, ideal for both television and

broadcast work, is an omnidirectional model, easily hidden behind lapel or necktie. Response is 60 to 12,000 Hz; input impedance is 50 to 150 ohms. The Collins M-70 provides highly directional sound selectivity, doubling the conventional working distance. Its cardioid pattern cuts out unwanted background noise. It comes equipped with desk stand and 20-foot cable. Response is 40 to 15,000 Hz; input impedance is 50 or 200 ohms, selectable. The Collins M-80 cardioid dynamic is ideal for night clubs, combos, recording, and public address. A 4-stage blast filter controls mike "pop", wind noise, and feedback. Response is 50 to 15,000 Hz; input impedance is 150 ohms (matches 50 to 250 ohms). The Collins M-90 cardioid dynamic features ball screen construction. Undesirable background noise, pops, squeals, and wind noise are all but eliminated. Response is 40 to 15,000 Hz; input impedance is 150 ohms (matches 50 to 250 ohms), discrimination is typically 20 dB over the entire frequency range.

M-21	124-0083-377	Lavalier Microphone
M-70	099-2402-000	Cardioid Microphone
M-80	124-0083-378	Cardioid Dynamic Microphone
M-90	124-0083-379	Cardioid Dynamic Microphone



M-70 M-80 M-90

Electro-Voice Microphones

Collins provides a complete line of Electro-Voice microphones for every possible application of the radio, television, entertainment, and recording industries. Omnidirectional models include the 649B miniature lavalier, ideal for programming where unobtrusive placement is desirable. It matches all low impedance inputs and comes with a 30-foot shielded cable. Frequency response is 70 to 10,000 Hz. Model RE-55 is a wide-range dynamic omnidirectional unit with flat response 40 to 20,000 Hz. It is ideal for orchestral or instrumental sound reinforcement. It matches low impedance inputs. The RE-50 omnidirectional has a four-stage pop and dust filter and is ideal for interviews, vocals

and instrumental music. It is windscreened for outdoor use. Response is 80 to 13,000 Hz; it has low impedance input. The redesigned and lightweight 635A is especially designed for vocals and interviewing. It also features a four-stage blast and pop filter. Response is 80 to 13,000 Hz; input is low impedance. A neck cord is furnished for lavalier-type applications. For discriminating sound applications, many super-cardioid dynamic models are available. Model RE-20 features wide, uniform response for exacting studio applications. It has a uniform cardioid polar pattern with off-axis response virtually identical to on-axis response. Response is 40 to 20,000 Hz; impedance is 50, 100, or 150 ohms. Model RE-15 meets handheld, boom, or stand applications. The directional pattern provides maximum rejection of 150° off axis. Response is 80 to 15,000 Hz; input is low impedance. The RE-16 is similar to the RE-15, but is designed for less exacting applications. The RE-11 is similar to the RE-10 and has characteristics of the RE-15, except that it has an integral blast and pop filter.

649B	NPN	Lavalier Microphone
RE-55	NPN	Omnidirectional Microphone
RE-50	NPN	Omnidirectional Microphone
635A	NPN	Omnidirectional Microphone
RE-20	NPN	Cardioid Microphone
RE-15	NPN	Cardioid Microphone
RE-16	NPN	Cardioid Microphone
RE-10	NPN	Cardioid Microphone
RE-11	NPN	Cardioid Microphone

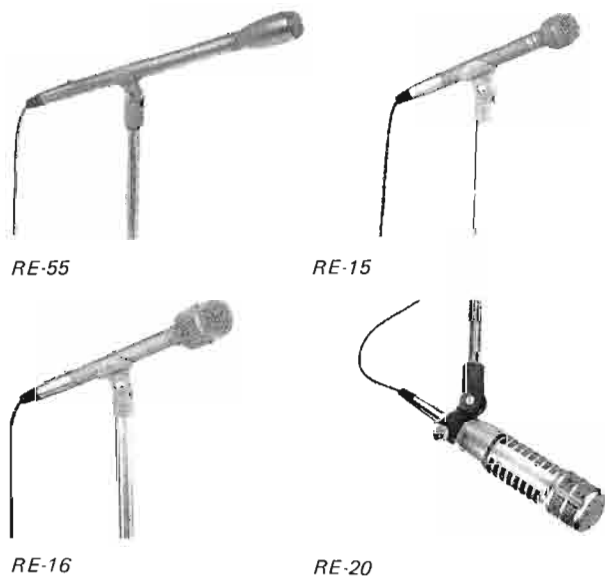

Shure Microphones

The SM53 unidirectional microphone is ideal for tight instrument and vocal pickup and for high-quality sound reinforcement applications. It has an extremely broad front working angle and holds tonal quality constant. It has built-in hum rejection system and integral pop filter. Response is 70 to 16,000 Hz; impedance is 50 to 150 ohms. For studio and remote applications, the SM50 self-windscreened omnidirectional model is ideal. Its primary applications are for news, sports and special events. Response is 40 to 15,000 Hz; it has dual impedance: 50 and 150 ohms. The SM60 omnidirectional model is designed for hand-held applications: performers, interviews, remotes, news, and sports. It has a built-in breath and pop filter. Response is 45 to 15,000 Hz; it matches any input from 50 to 250 ohms. Model SM51 meets lavalier requirements of broadcast, TV, and motion picture industries where a small unobtrusive mike is required. It is omnidirectional, with a frequency response of 70 to 12,000 Hz. It matches any input impedance from 50 to 250 ohms.

SM53	NPN	Unidirectional Microphone
SM50	NPN	Omnidirectional Microphone
SM60	NPN	Omnidirectional Microphone
SM51	NPN	Lavalier Microphone

Shure Microphone Accessories

To complement the line of microphones, Shure provides a complete line of mike accessories. The A15A Microphone Attenuator prevents input overload. Insertion loss is 15 dB. The A15HP High Pass Filter provides a low frequency cutoff to eliminate rumble or environmental sounds. Slope is 12 dB per octave. The A15LP Low Pass Filter provides high frequency cutoff for suppressing sibilance and hiss. Slope is 12 dB per octave. The A15PA Presence Adapter provides a response rise of 4 dB in the 3- to 5-kHz region, adding extra brilliance. The A15RS Response Shaper provides sibilance filtering and flattens response in mikes which show a rising characteristic in the 6-kHz region.

A15A	NPN	Attenuator
A15HP	NPN	High Pass Filter
A15LP	NPN	Low Pass Filter
A15PA	NPN	Presence Adapter
A15RS	NPN	Response Shaper



SM-53



MS-25

BS-36

Atlas Microphone Stands

Functional and modern in design, all Atlas stands feature chromed seamless tubing. All models terminate with standard 5/8-27 threads for mike or mike holder. Model DS-5 is a general purpose, nonadjustable unit with a 4-inch tube. Model DS-7 is similar, but has an adjustable tube from 8 inches to 13 inches. Model MS-25, for stage and studio, has an integral air suspension system to counterbalance mike weight. It is adjustable from 38 inches to 67 inches. Model BS-36 is a heavy-duty boom stand. The boom is 62 inches long; the height is adjustable from 48 inches to 72 inches.

DS-5	NPN	Microphone Desk Stand
DS-7	NPN	Microphone Desk Stand
MS-25	NPN	Microphone Floor Stand
BS-36	NPN	Microphone Boom Stand

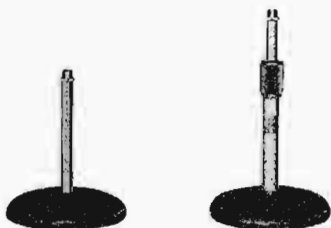

DS-5

DS-7

Flexo Mikester FM-1

This arm will handle any mike up to 4 pounds. It can be instantly positioned, incorporates a patented enclosed spring-controlled swiveling device, swings out 36 inches in any direction when fully extended. Clips or screws to any position. Clips hold cable in place.

FM-1	097-1499-00	Microphone Arm
------	-------------	----------------

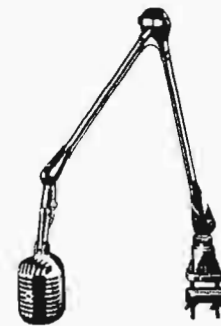

Flexo Mikester

Luxo Microphone Arms

Luxo arms are perfectly balanced to carry microphones to any desired position and remain there. LM-1 has a 41-inch reach; LM-2, 26-inch reach; LM-3, 56-inch reach; and LM-9, 21-inch reach. Mike weights of 7 to 13 ounces can be accommodated. Heavier mike capacities are available on special order.

LM-()	NPN	Microphone Arm
--------	-----	----------------

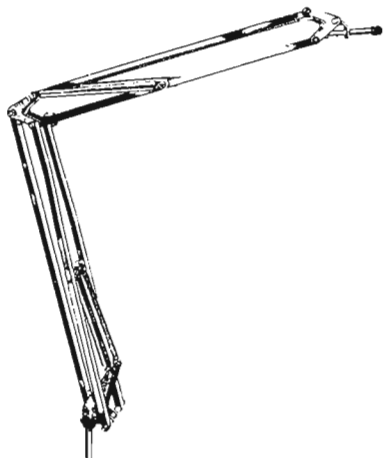

Luxo Mike Arm

SPEAKERS

Argos Baffles

Argos wall baffles enhance the decor of any studio. They are ruggedly constructed and finished in wood grain vinyl with modern cane grill. Either blond or walnut finish is available. There are no unsightly mounting brackets. Special clips are provided which mount to the wall and the baffle is hung like a picture. Model WB-12D is a regular baffle which will accommodate a 12-inch speaker. WB-8D is similar, but smaller, accommodating an 8-inch speaker. SCB-12D is a slanting corner mount unit designed for a 12-inch speaker; SCB-8D is similar in design, but sized for an 8-inch speaker.

WB-12D	NPN	Wall Baffle, 12-inch
WB-8D	NPN	Wall Baffle, 8-inch
SCB-12D	NPN	Corner Baffle, 12-inch
SCB-8D	NPN	Corner Baffle, 8-inch

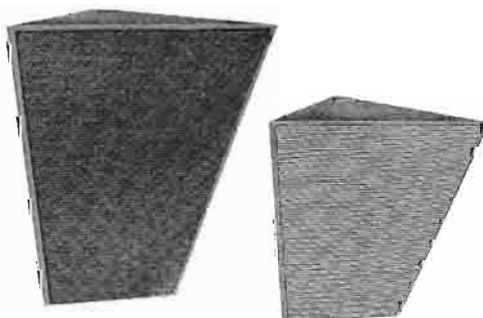

SCB-12D SCB-8D



WB-8D

Davis Speakers

The Davis shelf-size XEB-50 speaker system utilizes a modified Helmholtz design. Three speakers are used: 8-inch free-edge cone full range, a 3x5 mid-tweeter, and a 6-inch super-tweeter. Only 1 watt of power is required for the normal room. Power capacity is 25 watts; response is 37 to 19,000 Hz; impedance is 8 ohms. The cabinet is finished in walnut grain vinyl. The XEB-40 is a four-speaker system featuring a 15-inch woofer, 8-inch mid-range, 3x5 enclosed tweeter, and 6-inch super tweeter. Response is from 24 Hz to beyond audio range; impedance is 8 ohms, and power capacity is 50 watts. Bass response and brilliance controls are mounted on the rear of the cabinet.

SIZE:	(XEB-50)	12" (30.5 cm) H; 24" (67 cm) W; 10-1/2" (26.7 cm) D.
	(XEB-40)	24-1/2" (62.2 cm) H; 30" (76.2 cm) W; 14-1/2" (38.8 cm) D.
XEB-50	NPN	3-Way Speaker System
XEB-40	NPN	4-Way Speaker System

LS-12 Speakers

Producing LS-12 12-inch high fidelity sound, loudspeaker produces a consistently stable and precise definition. The speaker is designed to operate equally well at full range or as woofers in multiway systems. The LS-12 features Radax construction, which divides the sound between the two cones. A mechanical crossover, when the small cone responds to the higher frequencies, occurs at 1800 Hz.

An edge-wound voice coil, which gains an equivalent of five extra watts from most amplifiers over round-wire coils, is wound with precision, flattened ribbon conductor.

Frequency response is 30 to 13,000 Hz, power capacity is 40 watts peak, impedance is 8 ohms.

LS-12 NPN 12-inch Speaker

Stancor A-3818 Transformer

Transformer for LS-12, Jensen P12-T and P8-TS speakers. Primary impedance: 5000/1000/150 ohms; secondary impedance: 15/8/4 ohms; power rating: 25 watts.

A-3818 099-2686-00 Matching Transformer

Frazier Speakers

Frazier's newest bookshelf model, the F-10HA, has 30 watts of continuous power. It uses a 10-inch woofer joined to a new, special tweeter by a unique network with fixed acoustical tuning. Frequency response is 30 Hz to 17,000 Hz; impedance is 8 ohms. The cabinet is oiled walnut finish with brown fabric grille. Model F-103Y is built around the well-known "Black Box-1" system. Its modified Helmholtz tuning tube plus special 8-inch woofer, filter, and 3-inch tweeter, provide a response of 40 Hz to 15,000 Hz. Rated at 30 watts capacity, only 0.4 watt is required to drive the unit to room level volume. Input impedance is 8 ohms. (Black box utility models are available for built-in applications.)

SIZE:	(F-10HA)	24" (61 cm)H; 14" (35.6 cm) W; 12" (30.5 cm) D.
	(F-103Y)	19" (48.5 cm) H; 23-7/8" (60.6 cm) W; 11-7/8" (30.1 cm) D.
F-10HA	NPN	Speaker System
F-103Y	NPN	Speaker System



Frazier F-10-3Y

Telex Headsets

The Telex 1325 is a two-channel broadcast monitor headphone incorporating audiometric transducers. Either 600-ohm or 6000-ohm models are available. It is ideally suited to monitor stereo broadcasts or monaural broadcasts where program bus and cue bus are received on separate channels. Muffs and headband are foam-filled and the 12-foot cord is detachable. The Telex 1320 series is designed for a variety of communication requirements. Model CS-61 has dual muffs and dynamic mike; Model CS-75 has single muff and dynamic mike; Model CS-7 has dual muffs; Model CS-11 has single muff. Impedance of all these 1320 models is 600 ohms; usable response is 20 Hz to 20,000 Hz.

1325	NPN	Stereo Broadcast Headset
1320 [CS-()]	NPN	Communications Headset



Frazier F-10-HA



Telex 1325



Telex CS-61

AUDIO ACCESSORIES

Patch Cords

The plugs are of the shielded type, with the sleeves tied together and grounded. The circuit is maintained through connections to the plug tips. The following lengths are available: 6, 12, 24, 36, 48, 60, and 120 inches. Other patch plugs, phone jacks and single circuit jacks available.

NTN	361-0010-000	(6 in.)
NTN	361-0011-000	(12 in.)
NTN	361-0012-000	(24 in.)
NTN	361-0013-000	(36 in.)
NTN	361-0014-000	(48 in.)
NTN	361-0015-000	(60 in.)
NTN	361-0016-000	(120 in.)

Trimm Jack Panels

These panels are available in 12-pair, single row and 24-pair, double row models to fit any standard 19-inch rack and include such features as: solid 5/8-inch thick Bakelite panel with steel reinforcing; heavy gauge, special spring temper nickel/silver alloy leaves; ground lugs aligned to allow single ground bus to be run full length of strip; large palladium silver contacts; connection lugs fanned out for ease of soldering.

NTN	097-3561-000	12-pair, single row
NTN	097-4200-000	24-pair, double row

Cannon Connectors

Collins Radio Company is an authorized distributor of the full line of Cannon Connectors. The following is a listing of those connectors most often required in audio applications. All are 3-contact plugs unless otherwise indicated.

P3-CG-11S, Cannon female cable plug.
370-2180-000

P3-CG-12S, Cannon male cable plug.
370-2190-000

P3-13, Cannon female plug receptacle.
370-2060-000

P3-14, Cannon male panel receptacle.
370-2090-000

P3-35, Cannon single gang female wall receptacle.
370-2150-000

P3-35-2G, Cannon 2 gang female wall receptacle.
370-2170-000

XLR-3-11C, Cannon female cable plug.
097-5372-000

XLR-3-11SC, Cannon female cable plug with latch-lock cable clamp.
097-5371-000

XLR-3-12C, Cannon male cable plug.
097-5370-000

XLR-3-12SC, Cannon male cable plug with latch-lock cable clamp.
097-5369-000

XLR-3-13, Cannon female panel receptacle, flush mount.
097-5368-000

XLR-3-13N, Cannon female panel receptacle with lock nut.
097-5367-000

XLR-3-14, Cannon male panel receptacle, flush mount.
097-5366-000

XLR-3-14N, Cannon male panel receptacle with lock nut.
097-5365-000

XLR-3-35, Cannon single gang female wall receptacle.
097-5364-000

XLR-3-35-2G, Cannon 2-gang female wall receptacle.
097-5363-000

XLR-3-36, Cannon single gang male wall receptacle.
097-5362-000

XLR-3-36-2G, Cannon 2-gang male wall receptacle.
097-5361-000

UA-3-11, Cannon female cable plug.
370-2082-000

UA-3-12, Cannon male cable plug.
370-2081-000

UA-3-13, Cannon female panel receptacle, flush mount.
370-2079-000

UA-3-14, Cannon male panel receptacle, flush mount.
370-2083-000

UA-3-31, Cannon female wall mount receptacle.
099-0463-000

UA-3-32, Cannon male wall mount receptacle.
099-0464-000

ESE Digital Clock

ESE provides a complete line of digital clocks, timing devices, and counters. The ES 500 model is a combination six-digit clock and timer. There are five front-mounted controls for Start, Stop, Reset, Fast Advance, and Slow Advance.

ES-500 NPN Digital Timer/Clock



ES-500 Digital Timer/Clock



Telechron Studio Clock

Telechron 2012 Studio Clock

The Telechron "Commerce" clock has a 12-inch dial and rich brown case.

2012 114 0083 705 Studio Clock

Bud Rack Cabinets

A heavy duty rack cabinet that is custom-made for Collins Radio Company. Finished in light gray, this cabinet is made of sturdy steel with a door on the back and provision at the top for mounting a blower fan. CR-1773-B provides 77 inches of panel space. CR-1772 provides 63 inches of panel space. Both are shipped knocked down.

CR-1773-B 099-2474-000 22 in. W,
76 in. H,
17-1/8 in. D.

CR1772 124-0032-949 22 in. W,
69 in. H,
17-1/8 in. D.
For use with 820E/F
transmitter.



Bud Rack

Shielded Wire and Microphone Cable

8451—Belden 2-conductor #22, twisted pair, spiral-wrapped, shielding, vinyl insulation overall.

8738—Belden 2-conductor (solid copper) #22 vinyl insulated conductors, all shielded with copper braid.

439-5900-00—Two-conductor #22 stranded, 7 No. 30 conductors, one red and one black conductor with one #22 ground wire. Shield is single right-hand wrap, #30 AWG maximum diameter of stranding. Nylon jacket, maximum outside diameter is 0.140 in.

8422—Belden, shielded microphone cable, 2-conductor, #22, rubber covered.

8412—Belden, shielded microphone cable, 2-conductor #20, Neoprene covered.

423-0219-00 High voltage wire, 15-kV breakdown insulation.

425-0061-00 Shielded pair, #16 stranded cotton insulated, 15A.

425-0151-00 Shielded pair, #12 stranded cotton insulated, 20A.

124-0032-961 (Type 8451)

097-6029-000 (Type 8738)

097-1142-000 (Type 8422)

In lengths of less than 100 ft. More than 100 ft., see below.

097-1142-000 (Type 8422)

In lengths of 100 ft. or more. Less than 100 ft., see above.

425-0250-000 (Type 8412)

In lengths of less than 100 ft. More than 100 ft., see below.

425-0250-000 (Type 8412)

In lengths of 100 ft. or more. Less than 100 ft., see above.

Rack Cabinet Blank Panels

These blank panels of 3/16-inch aluminum are finished in light gray to match the BUD CR-1773-A Rack Cabinet.

Size: 19 in. (48 cm) W and in heights as listed below.

	Inches	Cm.
502-8389-123	(1-3/4 in.)	(4.45)
502-8393-113	(3-1/2 in.)	(8.89)
502-8397-123	(5-1/4 in.)	(13.34)
502-8401-113	(7 in.)	(17.78)
502-8405-113	(8-3/4 in.)	(22.23)
502-8409-123	(10-1/2 in.)	(26.67)
502-8413-113	(12-1/4 in.)	(31.12)
502-8417-113	(14 in.)	(35.56)

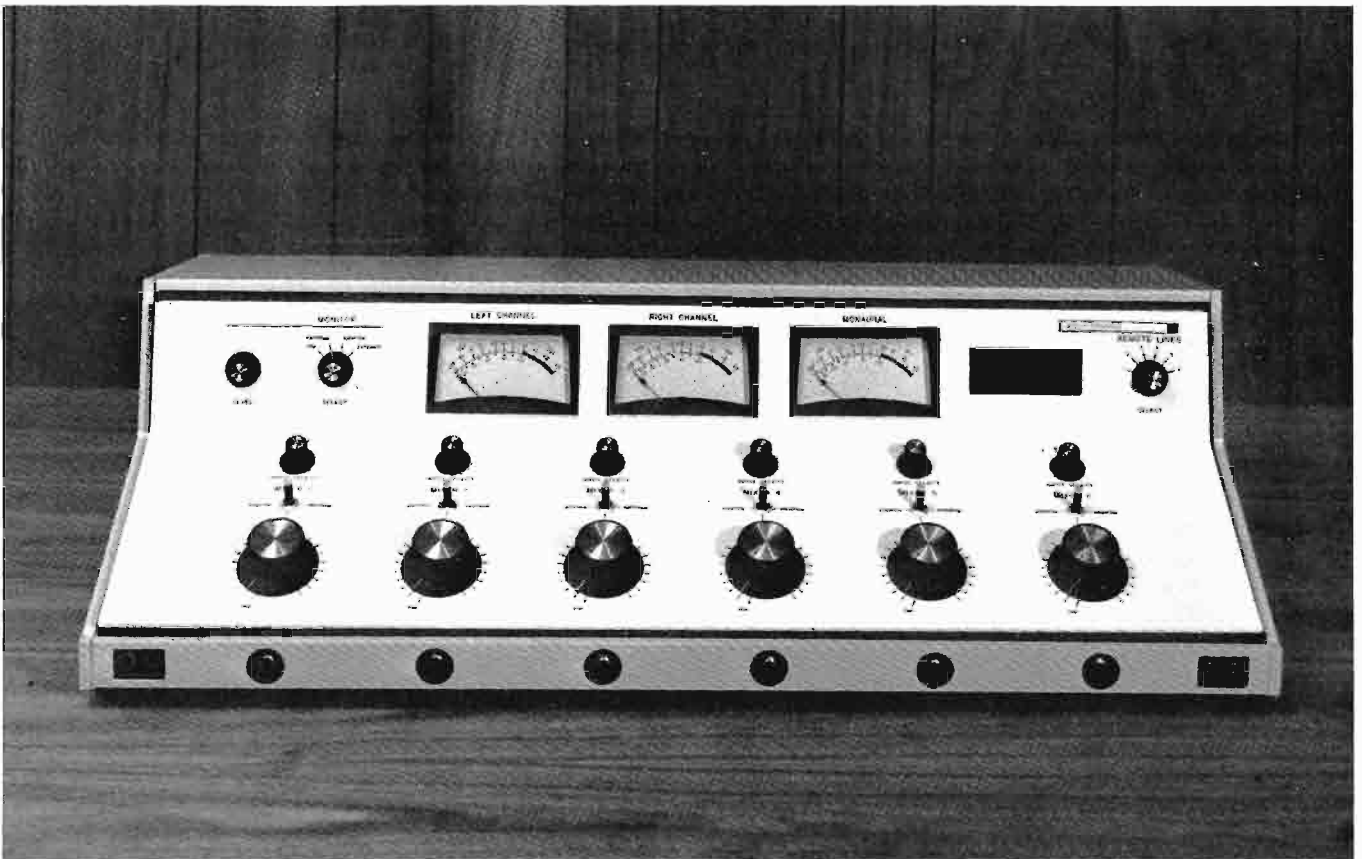
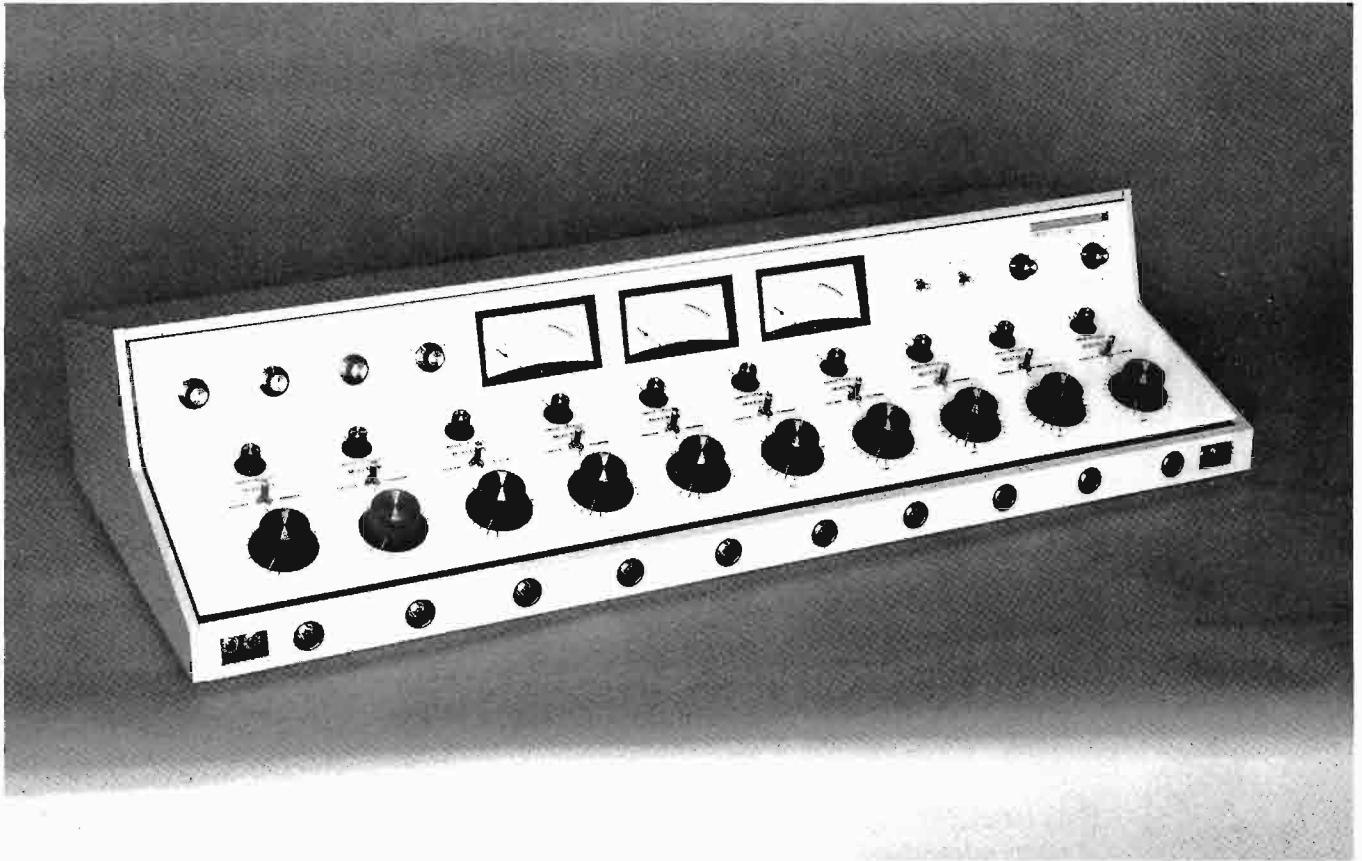



STL,
REMOTE,
MONITORING,
and TEST EQUIPMENT

STL EQUIPMENT

Marti STL-8F Transmitter

The Marti STL-8F, one of a series of two models designed to meet the exacting requirements of aural links, is ideal for the FM broadcaster requiring either mono or stereo operation. All solid state, the unit has a direct FM modulator, a field-proven varactor final, solid state ovens and high-accuracy crystals providing a frequency stability of $\pm 0.0005\%$. The 8-watt system operates in the 94.2- to 96.0-MHz range. Automatic switchover circuits are provided for a standby transmitter and rf sensing is built in for "out of status" alarm indication. Two of these units may easily be strapped together for stereo operation. The transmitter is available in either vertical (1/2-rack width) or horizontal (full rack width) configurations.

SIZE: (vertical) 7" (17.8 cm) H;
8-1/2" (21.6 cm) W;
15" (38 cm) D.

(horizontal) 8-3/4" (22.2 cm) H;
19" (48.5 cm) W;
8-1/4" (20.9 cm) D.

WEIGHT: (vertical) 15.5 lbs (7 kg)
less rack adapter

(horizontal) 20 lbs (9 kg)

STL-8F/V NPN Vertical Mount Transmitter, 8 watt, FM Applications

STL-8F/H NPN Horizontal Mount Transmitter, 8 watt, FM Applications



STL-8F Transmitter

Marti R200/950F Receiver

The Marti R200/950 series of receivers is the companion line for the STL-8 transmitters. The R200/950F model, designed for FM reception, is all solid state with plug-in

modular construction. A solid state oven and high accuracy crystal provides frequency stability of $\pm 0.0005\%$. Automatic switchover circuitry for a standby receiver is provided. Audio output is 600 ohms balanced with a maximum level of 18 dBm. Multiplex output provides for subcarrier and/or remote control signals. Like the transmitters, both vertical and horizontal configurations are available.

SIZE: (vertical) 7" (17.8 cm) H;
8-1/2" (21.6 cm) W;
15" (38 cm) D.

(horizontal) 8-3/4" (22.2 cm) H;
19" (48.5 cm) W;
8-1/4" (20.9 cm) D.

WEIGHT: (vertical) 9 lbs (4 kg) less rack adapter.

(horizontal) 16 lbs (7.3 kg)

R200/950F/V NPN Vertical Mount Receiver, FM Applications

R200/950F/H NPN Horizontal Mount Receiver, FM Applications

MTS-1 NPN Matching "T" Section for combining two receivers.

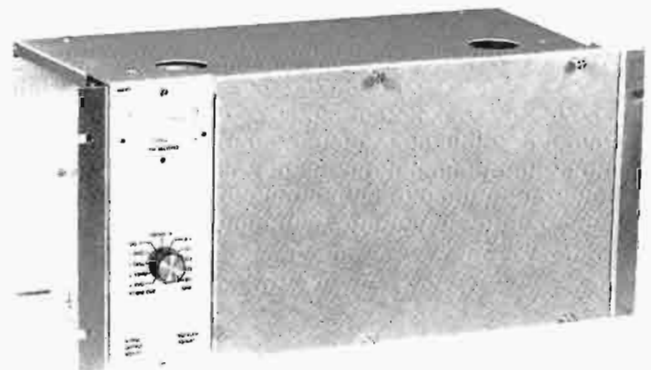

R-200/950 Receiver
STL Antennas

Mark Products P-948G Parabolic

The Mark P-948G Parabolic Antenna is of multi-grid construction and has extremely high strength and rigidity specifications. It will withstand wind thrust up to 100 miles per hour and yet weighs only 25 pounds. It is four feet in diameter. Operating in the 89.0- to 96.0-MHz range, the P-948G has a front-to-back ratio of 28 dB and gain of 18.9 dB.

SIZE: 4' (121.9 cm) Diameter

WEIGHT: 25 lbs (11.3 kg)

P-948G NPN 4' Parabolic Antenna

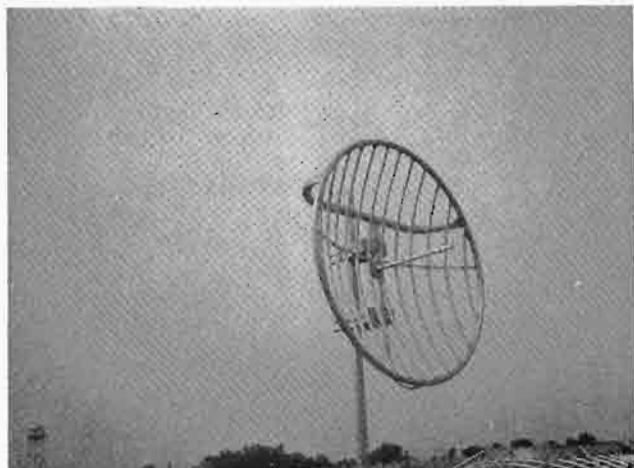

P-94G Antenna

Mark Products MG-944GN Parabolic

Weighing only 7 pounds, the Mark Products MG-944GN is a cylindrical parabolic antenna operating in the 940- to 960-MHz range. Gain is 13.5 dB; front-to-back ratio is 20 dB. Strength and rigidity is achieved through welded grid construction.

SIZE: 13-1/2" (29.2 cm) H;
44" (111.8 cm) W;
17" (43.2 cm) D.

WEIGHT: 7 lbs (3.2 kg).

MG-944GN NPN Cylindrical Parabolic Antenna

Decibel Products DB-496 Parabolic

For heavy-duty, high-gain applications, the Decibel Products DB-496 Cylindrical Parabolic Antenna offers a double-dipole directional radiator enclosed in a weather-proof radome. Grid construction of the reflector provides survival in winds up to 125 miles per hour. Forward gain is 13.5 dB; front-to-back ratio is 20 dB.

SIZE: 13-1/2" (29.2 cm) H;
42" (104.7 cm) W;
17" (43.2 cm) D.

WEIGHT: 9 lbs (4.1 kg)

DB-496 NPN Cylindrical Parabolic Antenna

STL Accessories

Marti CLA-40/A Compressor/Limiter

The Marti CLA-40/A is recommended for use between the audio control console and the STL transmitter to prevent link overmodulation. It combines the functions of limiting, compression, expansion and automatic gain control. It is both AM and FM compatible and two may be strapped together for FM stereo applications.

SIZE: 3-1/2" (8.9 cm) H;
19" (48.5 cm) W;
5-1/2" (14 cm) D.

WEIGHT: 6 lbs (2.7 kg)

CLA-40/A NPN Compressor/Limiter

Marti SCG-8H Subcarrier Generator

Intended for use in conjunction with an aural STL system, the Marti SCG-8H Subcarrier Generator will transmit any type of auxiliary program material from the studio to the transmitter location, via a link subchannel in the 39- or 67-kHz band. Frequency stability is ± 500 Hz; modulation is direct FM; modulation distortion is less than 1.5%.

SIZE: 3-1/2" (8.9 cm) H;
19" (48.5 cm) W;
5-1/2" (14 cm) D.

WEIGHT: 7.5 lbs (3.4 kg).

SCG-8H NPN Subcarrier Generator

Marti SCR-8H Subcarrier Receiver

A companion to the SCG-8H generator described above, the SCR-8H Subcarrier Receiver accepts signals in the 39-67 kHz range. Audio output level is +18 dBm; output impedance is 600 ohms balanced. As in the generator, an extremely sharp 6 kHz low-pass filter prevents subchannel to main channel crosstalk.

SIZE: 3-1/2" (8.9 cm) H;
19" (48.5 cm) W;
5-1/2" (14 cm) D.

WEIGHT: 7.5 lbs (3.4 kg)

SCR-8H NPN Subcarrier Receiver

Moseley PCL-303 Transmitter

The all solid state PCL-303 STL Transmitter uses the direct FM system. Frequency range is 890-960 MHz. Output power is 8 watts maximum; frequency stability is better than 0.001%. The transmitter has a modulation capability on one program and two subcarrier channels. The latter operate in the 25- to 100-kHz spectrum. Frequency response is ± 0.5 dB from 30 Hz to 15 kHz; distortion is less than 0.5% and signal to noise ratio is better than 68 dB below 100% modulation. The PCL-303 transmitter features all modular construction. It occupies only 5-1/4 inches of vertical rack space. The unit is mounted on slide-out rails for ease of inspection and maintenance. For stereo FM broadcasting, two units may be strapped together.

SIZE: 5-1/4" (15.3 cm) H;
19" (48.5 cm) W;
16" (40.6 cm) D.

PCL-303 NPN Transmitter, 8 watts, FM Applications



PCL-303 Transmitter

Moseley PCL-303 Receiver

Companion receiver to the PCL-303 Transmitter described above, this unit has like physical characteristics. Frequency range is 890-960 MHz. It is a superheterodyne type - double conversion and crystal controlled. It has a sensitivity of less than 3 microvolts for 20 dB quieting; selectivity is 200 kHz; audio output is 600 ohms balanced with a +10 dBm level. It can receive a program channel and two subcarriers.

SIZE: 5-1/4" (15.3 cm) H;
19" (48.5 cm) W;
14" (35.6 cm) D

PCL-303 NPN Receiver, FM Applications



PCL-303 Receiver

Moseley PCL-101 System

This transmitter and companion receiver is designed to meet requirements of international AM broadcasting. The transmitter employs direct FM modulation and maximum power output is 15 watts. It is available in 150 MHz, 220 MHz, or 450 MHz models. Other frequencies in the 148-470 MHz spectrum are available on special order.

SIZE: (Xmtr) 3-1/2" (8.9 cm) H;
19" (48.5 cm) W;
14" (35.6 cm) D.

SIZE: (Rcvr) 1-3/4" (4.4 cm) H;
19" (48.5 cm) W;
11" (27.9 cm) D.

PCL-101 NPN Transmitter, International AM Applications

PCL-101 NPN Receiver, International AM Applications

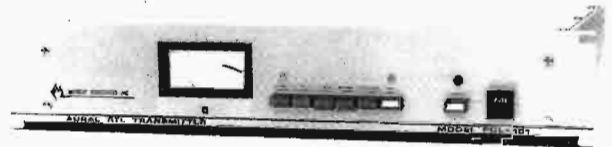

PCL-101 Transmitter

Moseley PCL-202 System

The Moseley PCL-202 System (transmitter and receiver) is similar to the PCL-303, except that it is designed to meet requirements of the international broadcaster. It operates in the 300- to 470-MHz band and has a maximum transmitter power output of 12 watts. It is intended to operate in a 100 kHz channel assignment.

SIZE: (Xmtr) 5-1/4" (15.3 cm) H;
19" (48.5 cm) W;
16" (40.6 cm) D

SIZE: (Rcvr) 5-1/4" (15.3 cm) H;
19" (48.5 cm) W;
14" (35.6 cm) D.

PCL-202 NPN Transmitter, 12 watts, International FM Applications.

PCL-202 NPN Receiver, International FM Applications

Scala PR-450U STL Antenna

Small and lightweight, the PR-450U is an ideal antenna for aural STL applications. Gain is 15 dB; front-to-back ratio is 20 dB, and polarization can be either horizontal or vertical. Net weight is only 25 pounds. The reinforced aluminum tube construction can withstand 100 mph winds. Frequency range is 350 MHz to 1 GHz. Impedance is either 52 or 72 ohms.

SIZE: 67" (170.2 cm) H; 36" (91.4 cm) W; 19" (48.5 cm) D.

WEIGHT: 25 lbs (11.3 kg)



PR-450U Antenna

Moseley SCG-3T Stereo Generator

Intended primarily as a companion to the Moseley PCL-303/C Single Link Stereo STL, the SCG-3T can be used for both stereo and monaural broadcasts. It will operate with most direct FM exciters. Left and right channel separation is 35 dB minimum, frequency response is ±1 dB, 30 Hz to 15 kHz.

SIZE: 3-1/2" (8.9 cm) H;
19" (48.5 cm) W;
11" (27.9 cm) D.

WEIGHT: 22 lbs (10 kg)

SCG-3T NPN Stereo Generator

Moseley SCG-4T Subcarrier Generator

The SCG-4T develops a direct FM subcarrier for multiplexing FM transmitters with an additional sound channel. It is available with a center frequency (must be specified) in the 25- to 185-kHz range. A front panel meter indicates peak deviation directly in kilohertz. All-electronic muting is employed, with adjustable time delay and manual override.

SIZE: 3-1/2" (8.9 cm) H;
19" (48.5 cm) W;
8-1/4" (20.9 cm) D.

WEIGHT: 7 lbs (3.2 kg)

SCG-4T NPN Subcarrier Generator

Moseley PCL-404 System

This transmitter and receiver system is ideal for the AM broadcaster with an aural STL requirement. Frequency range is 890-960 MHz. The system uses the direct FM method of transmission and reception. This provides flatter frequency response over a wider range with low distortion. Transmitter power output is 6.5 watts maximum. As in the other Moseley systems, all solid state circuitry is employed.

SIZE: (Xmtr) 5-1/4" (15.3 cm) H;
19" (48.5 cm) W;
13" (33 cm) D

SIZE: (Rcvr) 5-1/4" (15.3 cm) H;
19" (48.5 cm) W;
12" (30.5 cm) D

PCL-404 NPN Transmitter, AM Applications

PCL-404 NPN Receiver, AM Applications

REMOTE PICKUP EQUIPMENT

Marti RPT-40 Transmitter

The Marti RPT-40 Remote Pickup Transmitter is designed for continuous duty in the field. Its all solid state construction features a direct FM modulator, four audio mixing channels with individual level controls, built-in compressor/limiter for modulation control, and taut band circuit meter. Designed to operate in the 150- to 172-MHz range, the RPT-40 has a maximum output of 40 watts, frequency stability of $\pm 0.0005\%$, and capability to operate from either 115/230 volts ac or 13.6 volts dc. A selectable dual frequency operation is an optional feature.

SIZE: 6-1/4" (15.9 cm) H;
15" (38.1 cm) W;
12" (30.5 cm) D.

WEIGHT: 20 lbs (9 kg).

RPT-40 NPN Transmitter, 40 watts.



RPT-25/40 Transmitter

Marti RPT-25 Transmitter

The RPT-25 is similar in appearance to, and has many of the features of, the RPT-40. The RPT-25 is designed to operate in the 450- to 470-MHz spectrum. Output power is 25 watts maximum. The unit is compatible with unattended automatic relay devices.

SIZE: 6-1/4" (15.9 cm) H;
15" (38.1 cm) W;
12" (30.5 cm) D.

WEIGHT: 20 lbs (9 kg)

RPT-25 NPN Transmitter, 25 watts.

Marti R-30/150 Receiver

The rack-mounted R-30/150 Receiver mates with the RPT-40 Transmitter. An if. crystal filter provides maximum selectivity: 6 dB at ± 17.5 kHz with a 10.7/F30 filter module (optional filters are available). Audio output is 600 ohms at a +10 dBm level. Provisions for dual frequency operation are standard; the second crystal and switching assembly are extra cost items.

SIZE: 8-3/4" (22.2 cm) H;
19" (48.5 cm) W;
8-1/4" (20.9 cm) D.

WEIGHT: 16 lbs (7.3 kg)

R-30/150 NPN Receiver

Marti R-50/450 Receiver

Also a rack-mounted unit, the R-50/450 is designed to mate with the RPT-25 Transmitter. Other than its frequency range (450-470 MHz), it is electrically and mechanically similar to the R-30/150.

SIZE: 8-3/4" (22.2 cm) H;
19" (48.5 cm) W;
8-1/4" (20.9 cm) D.

WEIGHT: 16 lbs (7.3 kg)

R-50/450 NPN Receiver

Marti PA-1 Portable Antenna

The PA-1 is a single ring, portable antenna operating in the 150- to 170-MHz range. It is horizontally polarized and has unity gain. The PA-1 will mount directly on a 5/8" - 27 mike stand. As a mobile antenna (type MA-1), it can be mounted on a vehicle bumper.

PA-1 NPN Portable Antenna

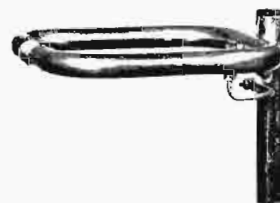

PA-1 Antenna

Marti YC Antennas

The YC series of antennas is ideal for mobile, portable, or base installations. Capable of handling 100 watts input power, the antennas have an average gain of 9 dB, rear signal rejection of 25 dB, and may be either horizontally or vertically polarized. Six different models are available (depending on frequency range selected).

YC-153	NPN	Antenna (152.80 - 153.40 MHz)
YC-161	NPN	Antenna (161.40 - 162.00 MHz)
YC-166	NPN	Antenna (165.95 - 166.55 MHz)
YC-170	NPN	Antenna (169.85 - 170.45 MHz)
YC-450	NPN	Antenna (450.05 - 450.95 MHz)
YC-455	NPN	Antenna (455.05 - 455.95 MHz)



YC Antenna

Marti ASPR-177 Antenna

Designed for rooftop mounting and operating in the 130- to 174-MHz range, the ASPR-177 is vertically polarized and has 3 dB gain. The unit includes a sealed, tamperproof transformer, cable, and connector.

ASPR-177	NPN	Antenna, rooftop mount
----------	-----	------------------------

Marti ASP-406 Antenna

The ASP-406 is a collinear rooftop antenna with solderless, weathertight mounting. It is easily adjusted by means of a setscrew for any frequency in the 450- to 470-MHz range.

ASP-406	NPN	Antenna, collinear rooftop mount
---------	-----	----------------------------------

Moseley RPL-3/4 Remote Pickup Links

Compactness and portability characterize the Moseley Associates RPL Series of remote pickup links. The RPL-3 is designed for 148- to 174-MHz operation; the RPL-4, 450- to 470-MHz. Each consists of a transmitter and receiver. The transmitters feature all solid state circuitry, 3-channel audio mixer, built-in power supplies (either 120/240 volts ac or 13.5 volts dc), built-in peak audio limiter, 15 watts maximum output, and full metering functions of all important parameters. The companion receivers occupy only 1-3/4" of standard 19-inch rack space. System specifications are: audio response – ±1.5 dB, 30 Hz to 10 kHz; distortion – less than 1.3%; signal-to-noise ratio – 55 dB below 100%.

SIZE: (Xmtr) 4" (10.2 cm) H;
14-1/2" (36.8 cm) W;
11" (27.9 cm) D

WEIGHT: 16 lbs (7.2 kg)

SIZE: (Rcvr) 1-3/4" (4.4 cm) H;
19" (48.5 cm) W;
10" (25.4 cm) D.

RPL-3 NPN Remote Pickup Link, 148-174 MHz

RPL-4 NPN Remote Pickup Link, 450-470 MHz.

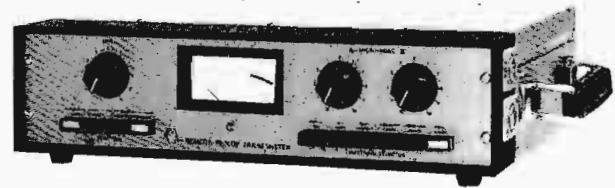

RPL-3/4 Transmitter

Moseley AMP Power Amplifier

This rf power amplifier is designed for use with Moseley remote pickup links when operated from a 13.5-volt dc power source. Gain is 6 dB.

AMP-3 NPN Power Amplifier, 150- to 170-MHz range

AMP-4 NPN Power Amplifier, 450- to 470-MHz range

KD20-B Portable Audio Console

Ideal for a complete facility remote broadcast operation, or as standby studio equipment, the KD20-B Console provides the broadcaster with complete capabilities: two RIAA-equalized phono inputs, two low-level mike inputs, a high-level (600 ohm) input, and a tape input. The turntables feature synchronous motors and three-speed operation. There are two outputs: a program line and a public address line that may be used to drive an external power amplifier. The unit uses standard 117-volt ac power, fed into a temperature-compensated and regulated power supply.

SIZE: 10" (25.4 cm) H;
 44" (111.8 cm) W;
 16-1/2" (42.1 cm) D.
 Standing height is 31" (78.7 cm).
 WEIGHT: 68 lbs (30.8 kg)
 WEIGHT: 68 lbs (30.8 kg)

KD20-B NPN Portable Audio Console



KD20-B Portable Audio Console

Shure M67 Mixer

Compact and lightweight, the Shure M67 Microphone Mixer is ideal for both studio and remote applications where several mikes are to be used. The unit accepts four low-level mikes, with one input convertible to line input. It has both 600 ohm line output and low-impedance mike output. There is noiseless switchover to battery operation (battery pack is an option) in case of ac line failure.

SIZE: 2-3/4" (7 cm) H;
 11-3/8" (28.9 cm) W;
 7-5/16" (18.6 cm) D.
 WEIGHT: 4.8 lbs (2.2 kg)

M67 NPN Microphone Mixer, 120 volts dc.
 M67-2E NPN Microphone Mixer, 240 volts ac (w/3-conductor cable).

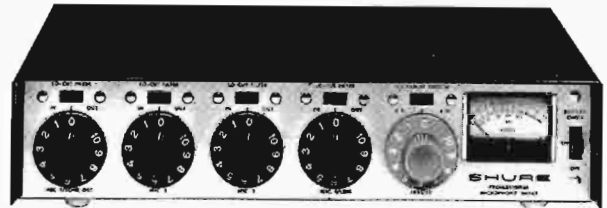

M67 Microphone Mixer

Shure SE30 Compressor/Mixer

The Shure SE30 combines the functions of a microphone mixer and a gain riding compressor that is automatic when set for a desired level. Compression range is 40 dB. A gated memory circuit eliminates "pumping" normally associated with audio compressors by sensing signal absence and placing a "hold" on the compression level at that point. The SE30 has four microphone inputs, self-contained battery and ac power supply with automatic switchover in case of ac failure and feedback gain controls.

SIZE: 3-15/16" (10 cm) H;
 15" (38.1 cm) W;
 10" (25.4 cm) D.
 WEIGHT: 9.8 lbs (4.4 kg)

SE30 NPN Compressor/Mixer



SE30 Compressor/Mixer

Shure M62V Level-Loc® Audio Level Controller

The Shure M62V reduces an overly strong input signal by as much as 100 times — automatically and instantly — to keep actual sound output at a predetermined level. It can operate from a self-contained battery or be powered from the Shure M67 Mixer.

SIZE: 2-1/2" (6.3 cm) H;
 11-3/4" (29.8 cm) W;
 5-1/4" (13.3 cm) D.
 WEIGHT: 2.2 lbs (1 kg).

M62V NPN Audio Level Controller

REMOTE CONTROL

Marti RMC-2AX System (10 or 24 Channel)

Designed and approved for both AM and FM sub-audible telemetry, the RMC-2AX system requires no interface equipment to meet FCC requirements; such circuits and components are built in. Of all solid state design and modular construction, the system is available in a 22-function model with 10 metering positions, or for more complex installations, in a 50-function model with 24 metering positions. Sub-audible telemetry is accomplished through use of a voltage-controlled oscillator, with a frequency shift of 22 to 28 Hz at a low percentage of modulation. A high-pass filter prevents program audio from modulating the metering channel. Automatic compensation is provided to limit modulation to 100% while telemetering. Optional accessories are available to provide smoke, fire, and unauthorized entry detection.

SIZE: (Studio Unit) 5" (12.7 cm) H;
19" (48.5 cm) W;
6-1/4" (15.9 cm) D.

WEIGHT: 14 lbs (6.3 kg).

SIZE: [Xmtr unit (10)] 7" (17.8 cm) H;
19" (48.5 cm) W;
9" (22.9 cm) D.

WEIGHT: 26 lbs (11.8 kg).

SIZE: [Xmtr unit (24)] 17-1/2" (44.5 cm) H;
19" (48.5 cm) W;
9" (22.9 cm) D.

WEIGHT: 30 lbs (13.6 kg)

RMC-2AX(10) NPN Remote Control System, 10 channels.

RMC-2AX(24) NPN Remote Control System, 24 channels.

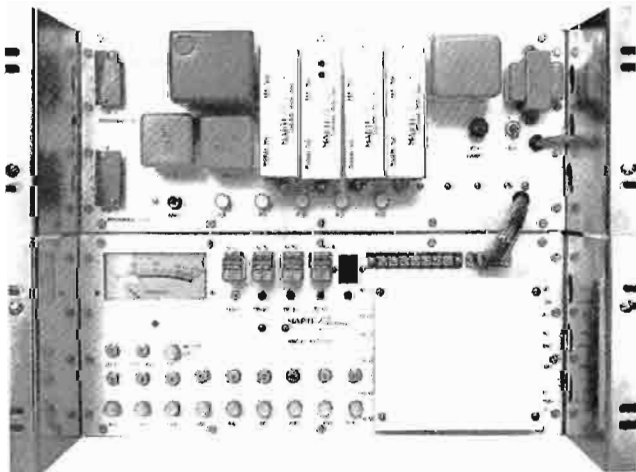

RMC-2AX Remote Control System

Marti DA-1 DC Operational Amplifier

Complete with its own ac power supply, the DA-1 is used to increase meter sampling voltages to the remote control system.

DA-1 NPN DC Operational Amplifier.

Moseley TRC-15A Remote Control Systems

Designed for both wire and wireless remote control, the TRC-15A system has 15 metering channels and 30 individual control functions. The TRC-15AW requires only a duplex, voice grade circuit interconnection; the TRC-15AR is the wireless model. Field conversion from one configuration to the other is accomplished by simply exchanging the appropriate modules. Fail-safe provisions in the TRC-15A meet all existing FCC requirements. They will function with the loss of primary power, interconnecting circuit failure, or an actual malfunction of the equipment itself. An interruption of the audio control tone carrier of approximately 15 seconds will trigger the fail-safe circuitry.

SIZE: (Studio Unit) 5-1/4" (13.3 cm) H;
19" (48.5 cm) W;
13-5/8" (34.6 cm) D.

(Xmtr Unit) 5-1/4" (13.3 cm) H;
19" (48.5 cm) W;
13-5/8" (34.6 cm) D.

TRC-15AW NPN Transmitter/Studio System, wireline interconnect

TRC-15AR NPN Transmitter/Studio System, wireless.



TRC-15A Remote Control System

Moseley PBR-30A Systems

Designed for more complex installations, the Moseley PBR-30A Systems will handle AM, FM, and TV remote control applications. The PBR-30AW is designed for voice grade telephone line (full duplex) interconnection. The PBR-30AR is designed to mate with Moseley aural STL equipment. Both systems offer 30 metering channels and 60 individual control functions. Included is a built-in, 5-input alarm function. This can be utilized for continuous surveillance of such parameters as fire, flooding, illegal entry, excessive temperature extremes, and many others.

SIZE: (Studio unit) 10-1/2" (26.7 cm) H;
19" (48.5 cm) W;
8-1/2" (21.6 cm) D

(Xmtr unit) 8-3/4" (22.2 cm) H;
19" (48.5 cm) W;
10-1/2" (26.7 cm) D.

PBR-30AW NPN Transmitter/Studio System, wireline interconnect

PBR-30AR NPN Transmitter/Studio System, wireless.

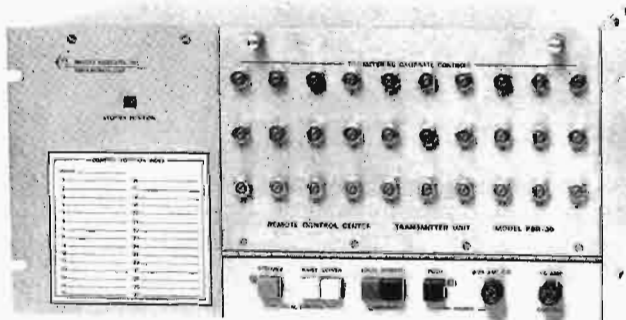

PBR-30A Remote Control System

MONITORS

Belar FMM-1 FM/Frequency/Modulation Monitor

This wideband, all solid state monitor fulfills requirements of monaural FM monitoring as well as providing a pure demodulated signal to drive a stereo and an SCA monitor in multiplex operations. The peak flasher operates independently of modulation polarity in that it samples both positive and negative peaks simultaneously and automatically selects and registers the greater amplitude if preset level is exceeded. The unit is type approved for remote monitoring.

SIZE: 5-1/4" (13.3 cm) H;
19" (48.5 cm) W;
10-1/2" (26.7 cm) D.

WEIGHT: 14 lbs (6.3 kg).

FMM-1 NPN FM Frequency/Modulation Monitor.

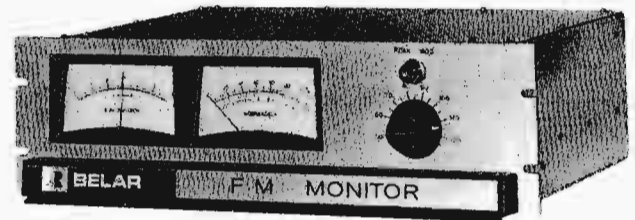

FMM-1 FM Frequency/Modulation Monitor

Belar FMS-1 FM Stereo Frequency/Modulation Monitor

When added to the FMM-1 FM Monitor, the FMS-1 provides complete monitoring and test functions for daily operations and provides additional facilities for weekly and monthly tests and maintenance checks. FM noise, AM noise, pilot frequency, separation, crosstalk, pilot amplitude, and subcarrier suppression all are read on the front panel. It may be used as an intermodulation analyzer to directly measure stereo distortion.

SIZE: 5-1/4" (13.3 cm) H;
19" (48.5 cm) W;
10-1/2" (26.7 cm) D.

WEIGHT: 12 lbs (5.4 kg)

FMS-1 NPN FM Stereo Frequency/Modulation Monitor.



FMS-1 Stereo Frequency/Modulation Monitor

Belar SCM-1 SCA Frequency/Modulation Monitor

The SCM-1, added to the FMM-1 Monitor, provides complete monitoring and test functions for SCA store-casting and remote telemetering applications. Up to four crystal switch positions allow four channels to be operated and tested. Interchangeable channel crystals permit unlimited SCA frequency selection.

SIZE: 5-1/4" (13.3 cm) H;
19" (48.5 cm) W;
10-1/2" (26.7 cm) D.

WEIGHT: 14 lbs (6.3 kg).

SCM-1 NPN SCA Frequency/Modulation Monitor

Belar RFA-1 FM RF Amplifier

This unit is a solid state FM rf amplifier for use in remote FM monitoring. It has 100 dB gain with a 70 dB dynamic range and 1 watt output. The 600 kHz phase linear bandwidth will not degrade a stereo multiplex transmission. The zero axis limiters and good selectivity characteristics (50 dB down at 800 kHz) insure that adjacent channel interferences are suppressed. Output impedance is 50 ohms.

SIZE: 3" (7.6 cm) H; 19" (48.5 cm) W; 11-7/8" (30.2 cm) D.

WEIGHT: 7 lbs (3.2 kg)

RFA-1 NPN FM RF Amplifier

Belar AMM-1 AM Frequency/Modulation Monitor

The unique AMM-1 features a separate 100% negative peak indicators, detecting absence of carrier and independent of any calibration procedures. The normal peak indicator lamp may be set to 125%. The true peak reading modulation meter is switchable to read either positive or negative peaks. A built-in off-frequency alarm driver permits unattended measurement of frequency. The ± 20 Hz frequency calibrator allows check of external equipment, such as automatic loggers.

SIZE: 5-1/4" (13.3 cm) H;
19" (48.5 cm) W;
10-1/2" (26.7 cm) D.

WEIGHT: 14 lbs (6.3 kg)

AMM-1 NPN AM Frequency/Modulation Monitor

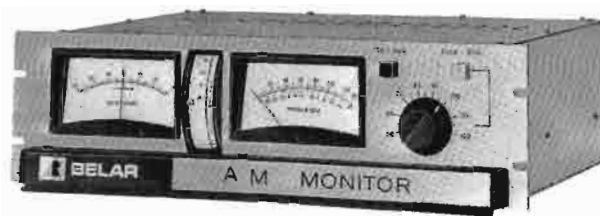

AMM-1 AM Frequency/Modulation Monitor

Belar RFA-2 AM RF Amplifier

Companion to the AMM-1 Monitor, the RFA-2 allows remote monitoring of carrier frequency deviation and modulation characteristics. Built-in automatic gain control eliminates problems associated with changes in transmitter power level, antenna patterns, and signal fading. Automatic gain control provides a range of more than 30 dB. The rf sensitivity is 100 μ V across 50 ohms.

SIZE: 3-1/2" (8.9 cm) H;
19" (48.5 cm) W;
11-1/2" (29.2 cm) D.

WEIGHT: 8 lbs (3.6 kg)

RFA-2 NPN AM RF Amplifier

TFT 723 FM Frequency/Modulation Monitor

The Model 723 receiver/monitor is designed for off-the-air monitoring of frequency and modulation parameters of FM transmitters. In addition to a peak reading modulation meter, it has two peak flashers which measure and display plus and minus peak modulation simultaneously. Flashers are calibrated from 50% to 129%, in 1-percent increments. The unit is usable as a six-digit precision frequency counter and has optional off-frequency alarm and optional BCD or analog automatic logging outputs. It also has stereo and SCA add-on capability.

SIZE: 7" (17.9 cm) H;
19" (48.4 cm) W;
16" (40.6 cm) D.

WEIGHT: 17 lbs (7.7 kg)

TFT 723 NPN FM Frequency/Modulation Monitor



TFT 723 FM Frequency/Modulation Monitor

TFT 724 FM Stereo Monitor

Used in conjunction with the 723 Monitor, this unit provides all stereo monitoring and proof-of-performance measurements as required by the FCC. It features separate left and right modulation metering; complete separation, crosstalk, injection, and signal to noise measurements; remote metering outputs, and (when used with the 723) digital display of pilot frequency.

SIZE: 7" (17.9 cm) H;
19" (48.4 cm) W;
17" (43.2 cm) D.

WEIGHT: 15 lbs (6.8 kg)

TFT 724 NPN FM Stereo Monitor



TFT 724 Stereo Frequency/Modulation Monitor

TFT 730 SCA Monitor

When used with Model 723 FM Monitor, the Model 730 monitors all characteristics of SCA transmission. Front panel pushbutton switches select SCA injection level, modulation, SCA FM signal to noise ratio and crosstalk. In addition to a peak reading modulation meter, two peak flashers measure and display plus and minus peak modulation, adjustable from 50% to 129%.

SIZE: 7" (17.9 cm) H;
19" (48.4 cm) W;
16" (40.6 cm) D.

WEIGHT: 15 lbs (6.8 kg)

TFT 730 NPN SCA Monitor

TFT 713 AM Frequency/Modulation Monitor

The Model 713 is designed for the broadcaster requiring off-the-air monitoring of carrier frequency and percent modulation of AM transmitters. Included is a digitally-set peak flash indicator displaying up to 129% modulation, a 100% negative peak flash indicator, built-in modulation calibrator, a 6-digit precision frequency counter, remote

metering and peak flasher outputs, provision for either BCD or analog automatic logging outputs, and optional +5% and -10% carrier level and carrier off alarm. Frequency accuracy of the unit is ± 2 Hz per year.

SIZE: 7" (17.9 cm) H;
19" (48.4 cm) W;
16" (40.6 cm) D.

WEIGHT: 17 lbs (7.7 kg)

TFT 713 NPN AM Frequency/Modulation Monitor

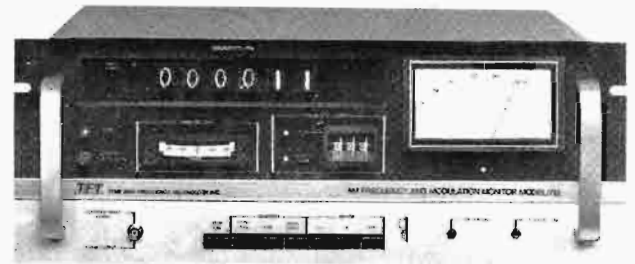

TFT 713 AM Frequency/Modulation Monitor

TFT 732 AM Modulation Monitor

The Model 732 is created for off-the-air monitoring of percent modulation of AM transmitters without using an rf amplifier. Included is a digitally-set peak flash indicator displaying up to 129% modulation, a 100% negative peak flash indicator, built-in modulation calibrator, and remote peak flasher outputs. Provision is made for automatic logging outputs. Adequate rf shielding is provided for reliable operation in a strong rf environment. The modulation meter is switchable from 0 to 133% on positive peaks, 0 to 100% on negative peaks. Accuracy is $\pm 2\%$ at 100% modulation, $\pm 4\%$ at any other percentage between 30 Hz and 10 kHz. Meter characteristics conform to FCC requirements. An output is provided for remote metering using TFT Model 704A. Power requirements of the unit are 115/230 volts ac, 50 to 400 Hz, 30 watts maximum.

SIZE: 7" (17.8 cm)H;
19" (48.5 cm)W;
16" (40.6 cm)D.

WEIGHT: 17 lbs. (7.7 kg).

732 NPN AM Modulation Monitor

Potomac Instruments AM-19 Antenna Monitor

The versatile AM-19 provides accurate measurement of phase angle and loop current in directional AM antenna systems. Phase measurement accuracy is ± 1.0 degree with a 0.5 degree resolution. Loop current indications are accurate to within $\pm 1.5\%$ with a resolution of 0.5%. Meters are individually calibrated. Tower selection is accomplished by pushbutton switches, offering the distinct advantage of switching from one tower to any other tower in the array without sequencing. The AM-19 is designed to accommodate DA-1, DA-2, and DA-3 patterns. Arrays from 2 to 12 towers may be monitored. Outputs are available for automatic logging. For extended frequency range, the AM-19D is available.

SIZE: 7" (17.9 cm) H;
19" (48.4 cm) W;
12-3/4" (32.4 cm) D.

AM-19 NPN Antenna Monitor



AM-19 AM Antenna Monitor

Potomac Instruments FIM-21 Field Intensity Meter

Lightweight and highly stable, the FIM-21 provides precise electromagnetic field measurements in the 535- to 1605-kHz range. Field intensities between 10 microvolts/m and 10 volts/m are directly indicated on the front panel meter. The printed circuit loop antenna is an integral part of the cover and is coupled to the instrument automatically when the cover is opened. Built-in standard "D" cells will provide approximately 1,000 readings, dependent on use of meter lights and volume setting of the integral loudspeaker. Calibration accuracy is 1%, referenced to 220 millivolts per meter.

SIZE: 8-3/4" (22.2 cm) H;
11-1/2" (29.2 cm) W;
5-1/8" (13.0 cm) D
(cover closed).

WEIGHT: 11.5 lbs (5.2 kg)

FIM-21 NPN Field Intensity Meter

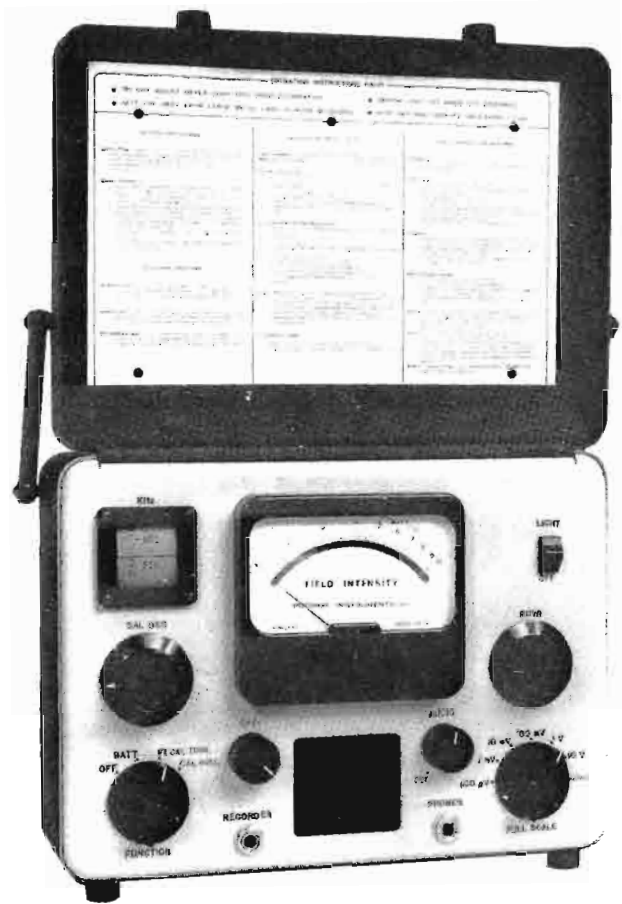

FIM-21 Field Intensity Meter

Potomac Instruments FIM-41 Field Intensity Meter

This unit is physically similar to the FIM-21 except that it operates in the frequency range of 540 kHz to 5 MHz.

SIZE: 8-3/4" (22.2 cm) H;
11-1/2" (29.2 cm) ;
5-1/8" (13 cm) D
(cover closed)

WEIGHT: 11.5 lbs (5.2 kg)

FIM-41 NPN Field Intensity Meter

TEST EQUIPMENT

Delta OIB-1 Operating Impedance Bridge

Operating in the 500-kHz to 5-MHz range, the OIB-1 measures operating impedance of radiators, networks, transmission line sections, and common point of directional antenna systems while they are functioning normally and under full power. The unit is inserted directly in series with the equipment to be measured. Transmitter power is applied and a bridge balance obtained by manipulation of the two dials. Resistance and reactance can then be read directly. The vswr can be read from a meter scale. Through power rating of the unit is 5 kW modulated; 10 kW carrier only. Accuracy is $\pm 2\%$, ± 1.0 ohm.

SIZE: 5-1/4" (13.3 cm) H;
9-1/2" (24 cm) W;
12-1/2" (31.7 cm) D.

WEIGHT: 10 lbs (4.54 kg)

OIB-1 NPN Operating Impedance Bridge



OIB-1 Operating Impedance Bridge

Delta CPB-1/1A Common Point Impedance Bridge

These two bridges are similar in operation to the OIB-1 model, but are designed for permanent installation in the phasing equipment at the antenna common point. The CPB-1 will handle common point powers up to 5 kW with 100% amplitude modulation on a continuous basis. The CPB-1A is designed for transmitter powers up to 50 kW.

SIZE: (without panel) 7" (17.8 cm) H;
9" (22.8 cm) W;
9-1/4" (23.5 cm) D.

(panel size) 7" (17.8 cm) H;
19" (48.5 cm) W.

WEIGHT: 12 lbs (5.4 kg)

CPB-1 NPN Common Point Impedance Bridge, 5 kW

CPB-1A NPN Common Point Impedance Bridge, 50 kW



CPB-1 Common Point Impedance Bridge

B & W 210 Audio Oscillator

This unit provides low distortion signals from 10 Hz to 100 kHz. An RC audio circuit is followed by an amplifier with extremely low distortion characteristics. It is ideal for testing broadcast station response, high fidelity equipment, filter characteristics, and any equipment requiring a signal of a known frequency.

SIZE: 9" (22.8 cm) H;
6" (15.2 cm) W;
12" (30.5 cm) D.

WEIGHT: 11 lbs (5 kg)

210 NPN Audio Oscillator



B & K 210 Oscillator

B & K 410 Distortion Meter

B & W 410 Distortion Meter

Designed as a companion instrument for the Model 210 Audio Oscillator, this distortion meter measures audio distortion, noise level, audio gain or loss in decibels, and ac voltages. Measurements are read directly on the front panel meter. It is a useful device for measurements for FCC proof-of-performance tests.

SIZE: 9" (22.8 cm) H;
11-1/4" (27.6 cm) W;
12" (30.5 cm) D.

WEIGHT: 11 lbs (5 kg)

410 NPN Distortion Meter.

Ailtech F370A Audio Sine Generator

This equipment, with a high output level of 5 watts, is ideal for obtaining accurate gain and frequency response measurements, as a voltage source for distortion testing, and as an all-around test device for the broadcaster. It covers a frequency span of 20 Hz to 20 kHz in three decades through a modified Wien bridge oscillator, ensuring low distortion output. Output power may be inserted into resistive loads of 50, 200, 600, and 5,000 ohms.

SIZE: 5-1/4" (13.3 cm) H;
17" (43.2 cm) W;
13" (33 cm) D.

WEIGHT: 25 lbs (11.3 kg)

F370A NPN Audio Sine Generator



F370A Audio Generator

Fluke 1980A Frequency Counter

The 1980A VHF/UHF Frequency Counter may be operated from standard line voltage, or from an optional 12-volt dc battery pack. Its range is from 5 Hz to 50 MHz (direct input) and from 25 MHz to 515 MHz (prescaled input). A variable trigger level control on the direct input helps eliminate erroneous readings due to sine waves with noise spikes or ringing square waves. Readout is automatically displayed on a 6-digit LED display. The 1980A is an invaluable tool for accurate frequency determination of all types of laboratory devices, transmitters, exciters, oscillators, and any type of communication equipment.

SIZE: 3" (7.62 cm) H;
6-1/2" (16.5 cm) W;
8" (20.3 cm) D.

WEIGHT: 4.75 lbs (2.2 kg)

1980A NPN VHF/UHF Frequency Counter



1980A Frequency Counter

Ailtech F380A Audio Sine Generator

Designed especially for precision and dependability required by professional audio and broadcast personnel, the F380A features ultra-low distortion through its range of 20 Hz and 20 kHz: Distortion is less than 0.1%. Three separate output attenuators permit reduction of the oscillator level in 0.1 dB steps to a maximum of 111 dB. Output is ± 15 dBm into impedances of 50, 150, and 600 ohms. It is ideal for FM exciters, transmitters, amplifier response, and sound reinforcement and distribution systems.

SIZE: 5-1/4" (13.3 cm) H; 17" (43.2 cm) W;
13" (33 cm) D.

WEIGHT: 21 lbs (9.5 kg)

Fluke 8000A Digital Multimeter

Pushbutton control practically eliminates operational error with the 8000A. There are 26 different ranges, including five ranges of ac and dc voltage, five ranges of ac and dc current, and six ranges of resistance. Ranges include: ac voltage – 199.9 mV to 1199 V; dc voltage – ± 199.9 mV to ± 1199 V; ac current – 199 μ A to 1999 mA; dc current – ± 199.9 mV to ± 1999 mA; resistance – 199.9 ohms to 19.99 megohms. Values are read directly on an LED display.

SIZE: 2-1/2" (6 cm) H;
8-1/2" (22 cm) W;
10" (25 cm) D

WEIGHT: 2.75 lbs (1.2 kg)
without batteries.

8000A NPN Digital Multimeter



TABLES
CHARTS
GRAPHS

Footage Table for Broadcast Tower Heights

550 KHZ TO 1070 KHZ					1080 KHZ TO 1600 KHZ				
KHZ	METERS	1 WAVE	1/2 WAVE	1/4 WAVE	KHZ	METERS	1 WAVE	1/2 WAVE	1/4 WAVE
550	545	1787.6	893.8	446.8	1080	277.8	911.1	455.5	227.7
560	536	1758.0	879.0	439.5	1090	275.2	902.6	451.3	225.6
570	526	1725.3	862.6	431.3					
580	517	1695.7	847.8	423.9	1100	272.7	894.4	447.2	223.6
590	509	1669.5	834.7	417.3	1110	270.3	886.5	443.2	221.6
					1120	267.9	879.0	439.5	219.7
600	500	1640.0	820.0	410.0	1130	265.5	870.8	435.4	217.7
610	492	1612.7	806.3	403.1	1140	263.2	862.6	431.3	215.6
620	484	1587.5	799.7	396.8	1150	260.9	855.7	427.8	213.9
630	476	1561.2	780.6	390.3	1160	258.6	847.8	423.9	211.9
640	469	1546.3	773.1	386.5	1170	256.4	840.9	420.4	210.2
650	462	1515.3	757.6	378.8	1180	254.2	834.7	417.3	208.6
660	455	1492.4	746.2	373.1	1190	252.1	826.8	413.4	206.7
670	448	1469.4	734.7	367.3					
680	441	1446.4	723.2	361.1	1200	250.0	820.0	410.0	205.0
690	435	1426.8	713.4	356.2	1210	247.9	813.1	406.5	203.2
					1220	245.9	806.3	403.1	201.5
700	429	1407.1	703.5	351.2	1230	243.9	799.1	399.5	199.7
710	423	1387.4	693.7	346.8	1240	241.9	793.7	396.8	198.4
720	417	1367.7	683.8	341.9	1250	240.0	787.2	393.6	196.8
730	411	1348.0	674.0	337.0	1260	238.1	780.9	390.4	195.2
740	405	1328.4	664.2	332.1	1270	236.2	774.7	387.3	193.6
750	400	1312.0	656.0	328.0	1280	234.4	768.8	384.4	192.2
760	395	1295.6	647.8	323.4	1290	232.6	762.9	381.4	190.7
770	390	1279.2	639.6	319.8					
780	385	1262.8	631.4	315.7	1300	230.8	757.0	378.5	189.2
790	380	1246.4	623.2	311.6	1310	229.0	751.1	375.5	187.7
					1320	227.3	746.2	373.1	186.5
800	375	1230.0	615.0	307.5	1330	225.6	739.9	369.9	184.9
810	370	1213.6	606.8	303.4	1340	223.9	734.7	367.3	183.6
820	366	1200.4	600.2	300.1	1350	222.2	728.8	364.4	182.2
830	361	1184.0	592.0	296.0	1360	220.6	723.2	361.1	180.5
840	357	1170.9	585.4	292.7	1370	219.0	718.3	359.1	179.5
850	353	1157.8	578.9	289.4	1380	217.4	713.4	356.2	178.1
860	349	1144.7	572.3	286.1	1390	215.8	707.8	353.1	176.5
870	345	1131.6	565.8	282.9					
880	341	1118.4	559.2	279.6	1400	214.3	703.5	351.2	175.6
890	337	1105.3	552.6	276.3	1410	212.8	696.9	348.4	174.2
					1420	211.3	693.7	346.8	173.4
900	333	1092.2	546.1	273.0	1430	209.8	688.1	344.0	172.0
910	330	1082.4	541.2	270.6	1440	208.3	683.8	341.9	170.9
920	326	1069.2	534.6	267.3	1450	206.9	678.6	339.3	169.6
930	323	1059.4	529.7	264.8	1460	205.5	674.0	337.0	168.5
940	319	1046.3	523.1	261.5	1470	204.1	669.4	334.7	167.3
950	316	1036.4	518.2	259.1	1480	202.7	664.2	332.1	166.5
960	313	1026.6	513.3	256.6	1490	201.3	660.2	330.1	165.0
970	309	1013.5	506.7	253.3					
980	306	1003.6	501.8	250.9	1500	200.0	656.0	328.0	164.0
990	303	993.8	496.9	248.4	1510	198.7	651.7	325.8	162.9
					1520	197.4	647.8	323.4	161.7
1000	300	984.0	492.0	246.0	1530	196.1	643.2	321.6	160.8
1010	297	974.1	487.5	243.7	1540	194.8	639.6	319.8	159.9
1020	294.1	964.6	482.3	241.1	1550	193.5	634.6	317.3	158.6
1030	291.3	955.3	477.6	238.8	1560	192.3	631.4	315.7	157.8
1040	288.5	946.2	473.1	236.5	1570	191.1	626.8	313.4	156.7
1050	285.7	937.1	468.5	234.2	1580	189.9	623.2	311.6	155.8
1060	283.0	928.2	464.1	232.0	1590	188.7	618.9	309.4	154.7
1070	280.4	919.7	459.8	229.9	1600	187.5	615.0	307.5	153.7

**Distance in Miles From an FM Transmitter to
Its 54 dbu (0.5 mv/m) Contour for Various Heights and Powers**

AHAAT IN FT	POWER IN DBK																					
	-20	-18	-16	-14	-12	-10	-8	-6	-4	-2	0	2	4	6	8	10	12	14	16	18	20	
2400	20	22	24.5	27	30	34	38	42	47.5	51.5	55	60	65	69.5	73	78	82	87	91.5	95	100	113.5
3200	19	22	25	29	32.5	37	40.5	45	50	53.5	58.5	63	67	71	75	80	85	90	93	97	100.5	
3000	18.5	21.5	24.5	28	31.5	35	40	43	48	52	56.5	60.5	65	69.5	73	77.5	82	86.5	91.5	95	98.5	
2800	18	20.5	23	27	30	33.5	38	42	45.5	50	54.5	58.5	63	67	71	75	80	84	89	93	96	
2600	17.5	20	22	25.5	29	32	36	40	44.5	48.5	52	56	60	65	69	73	77	81.5	85.5	90	94	
2400	17	19	21.5	24.5	28	31	35	38.5	42	46	50.5	54.5	58.5	62	67	70.5	75	78.7	83	88	92	
2200	16	18.2	20	23	26.5	29	32.5	36.5	40	44.5	48	52	55.5	60	65	68	72	76.5	80	85	90	
2000	15	17.4	19	22	25	28	31	35	38	42	45.5	50	53	57	61.5	65	69.5	73.7	78	82	86	
1900	15	17	18.5	21.5	24.5	27	30	33.5	37.5	40.5	45	48.5	52	55.5	60	64	68	72	76	80	85	
1800	14	16	18	20.5	23	26.5	29	32.5	36	40	43	47.5	51	55	58.5	62.5	66	70	75	79	83	
1700	13.5	15.5	17.5	20	22.5	25	28	31.5	35	38	42	45.5	50	53	57	60.5	65	69	71.5	77	81	
1600	13	15	17	19	21.5	24.5	27	30	33	36.5	40.5	44	48	52	55.5	60	63	67	71	75	80	
1500	12.5	14.6	16.5	18.5	21	23.5	26.5	28.5	32	35.5	39.5	43	46.5	50	54.5	58	61.5	65	69.5	73	78	
1400	12	14	16	18	20	22	25	28	30.5	34.5	38	41.5	45	48.5	52.5	56	60	63	67	71.5	75	
1300	11.5	13.4	15.5	17	19	21.5	23.5	27	30	32.5	36	40	43	47	50.5	55	58	61.5	65	70	73.5	
1200	11	13	14.5	16.5	18.5	20.5	23	25.5	28	31	35	38	41.7	45	48.5	52.5	56	60	63	67	71.5	
1100	10	12	13.5	15.5	17.5	19.5	21.5	24.5	26.5	30	33	36.5	40	43	47	50.5	54.5	58	61.5	65	70	
1000	9.7	11.5	13	15	17	18.5	20.5	23	25.5	28	31.2	34.5	38	41	45	48	52	56	58.5	63	68	
900	8.7	10.5	12	14	16	18	19.5	21.5	24.5	27	29.6	32.5	35.5	38.5	42.5	46	50	54	57	60.5	65	
800	8.2	9.7	11.5	13	15	16.5	18	20	22	25	28	30.5	33.5	37	40	43	47	51	55	58.5	63.5	
700	7.7	8.7	10.5	12	13.5	15.5	17	18.5	21	23	26	28.5	32	35	38	41	45	49	53	56.5	63	
600	7.2	8	9	11	12	14	15.5	17.5	19	21.5	24	26.5	28.7	32	35	38	42	45.5	50	55	60	
500	6.5	7.3	8.2	9	11	12.5	14	16	17.5	19	22	24	27	29	32.5	35.5	38.5	43	47	52	57	
400	5.8	6.6	7.3	8.3	8.5	11	12.5	14	16	17.5	19	22	24.5	27	29.5	32	35.5	40	43.5	49.5	55	
300	5	5.7	6.5	7.2	8	8.7	10.5	12	13.5	15	17	18.5	21	23.5	26.5	28.5	32	35.5	40	45.4	52	
200	4	4.6	5.2	5.7	6.5	7.3	8.2	9	11	12	13.7	15.5	17.5	19	22	24.5	28	31.5	35	42	48	
100	2.8	3.2	3.7	4.1	4.6	5.2	5.8	6.6	7.4	8.2	9	10.7	12.5	14	16	18.2	21.5	25	30	35.5	45	

**Distance in Miles From an FM Transmitter to
Its 60 dbu (1 mv/m) Contour for Various Heights and Powers**

AHAAT IN FT	POWER IN DBK																					
	-20	-18	-16	-14	-12	-10	-8	-6	-4	-2	0	2	4	6	8	10	12	14	16	18	20	
3400	11	13	15	17.5	20	22.5	27	30	34	37	40.5	45	49	52	57	60	64	65	65	65	65	
3200	11	12.2	14.5	16.5	19.5	22	25	26.5	32	35	39	42.5	47	50.5	55	59	62	64	65	65	65	
3000	10.5	12	14	16	19	21.5	24.5	28	31	34	38	41	45	49.5	53	57	60	64	65	65	65	
2800	10	11.8	13.5	15.7	18	20.5	24	26.5	30	33	36	40	44	48	51	55	59	62	64	65	65	
2600	9.7	11.5	13	15	17	20	22.5	25.5	29	32	35	39	42	46	49.5	53	58	60	63	64	65	
2400	9.4	11	12.8	14	16	19	21.5	24.5	28	30.5	34	37	40	44	47.5	51	55	59	61	64	65	
2200	9.2	10.8	12	13.5	15.5	18	20.5	23.5	26	29	32	35	39	42	45.5	49	52	56.5	59.5	62	65	
2000	9	10.2	11.2	12.1	15	17	20	22	25	28	30	33.5	37	40	44	46.5	50.5	54	57.5	60.5	64	
1900	8.7	10	11.2	12.7	14.5	16.5	19	21.5	24.5	27	29.5	33	35.5	39	43.5	45.5	49.5	52.5	55.5	59.5	62	
1800	8.5	9.7	11	12.6	14	16	18	20.5	23.5	25.5	29	31.5	35	38.5	43	44.5	48.5	51.5	55	59	61	
1700	8.3	9.2	10.5	11.6	13.8	15.5	17.3	20	22.5	25	28	30	33	37	40	43	46.5	50	53	57.5	60	
1600	8.1	9	10.3	11.5	13.2	15	17.1	19.2	21.5	24	26.5	29.5	32.5	35.5	39	42	45	49	51.5	55	58	
1500	8	9	10	11.4	13	14.9	16.9	18.6	21	23	26	28.5	31.5	35	38	40.5	44	47	50.1	54	57	
1400	7.5	8.6	9.7	11.2	12.5	14	16.2	18	20	22	25	27.5	30	33	36	40	43	46	48.5	52	55	
1300	7.3	8.2	9.3	10.5	12	13.8	15.5	17.5	19	21.5	24	26.5	29	32.5	35	39	41.5	45	47.5	51	54	
1200	7	7.8	9	10	11.5	13	15	17	18	21	23	25.5	28	31	34	37.5	40	44	46	49	52	
1100	6.8	7.6	8.5	9.5	11	12.5	14.5	16	17.1	20	22	24.5	26.5	29.5	32	35	38	41	43.5	47	50	
1000	6.4	7.2	8	9	10.2	12	14	15.6	17	19	21	23	25.5	28	31	34	36.5	40	43	45.5	49	
900	6.2	6.8	7.8	8.8	9.7	11.2	12	14.5	16.4	18	20	21	24.5	26	29	32	35	38	40.5	44	47	
800	5.8	6.6	7.3	8.2	9.2	10.3	12	13.5	15.2	17	18.5	20.5	22	25	27.5	30	33	36	39	41.5	45	
700	5.4	6.2	7	7.8	8.6	9.7	10.5	13	14	16	17	19.2	21	24	26	28.5	31	33	36	39	42	
600	5	5.7	6.5	7.1	8	9	9.8	11.8	12.3	14.5	16	18	19.7	21.5	24	26	29	32	35	36.5	40	
500	4.6	5	5.8	6.6	7.3	8.2	9	10	12	13.2	14.5	16.1	17.9	20	22	24.5	27	29.5	31.5	35	37	
450	4.2	4.8	5.5	6.2	7.0	7.8	8.6	9.6	10.5	12.5	14.0	15.2	17.0	19.0	20.5	23.0	25.4	28	30	33	36	
400	4	4.6	5.1	5.9	6.6	7.4	8.2	9	10	11.8	12.5	14.5	16	17.8	19.8	21.5	24.5	26.5	29	31.5	35	
350	3.8	4.2	4.8	5.3	6.1	7.0	7.8	8.6	9.5	10.3	11.0	14.0	15	16.8	18.5	20.2	23	25	27.5	30	33	
300	3.6	4	4.5	5	5.7	6.3	7.2	8	8.8	10	10.5	12.6	14	15.6	17	19	21	23	25.5	28	30	
250	3.2	3.7	4.0	4.6	5.1	5.9	6.7	7.3	8.0	8.9	9.9	10.6	12.5	14.0	15.8	17.8	19	21.5	24	26	28	
200	2.9	3.3	3.7	4.1	4.7	5.1	5.9	6.6	7.4	8.1	9	10	11.3	12.5	14	15.5	17.5	19.5	21.5	24	26	
150	2.5	2.8	3.2	3.6	4.0	4.5	5.0	5.7	6.4	7.1	7.9	8.8	9.7	10.8	12	14.0	15.2	17.0	19	21	24	
100	2	2.3	2.7	2.9	3.2	3.8	4.1	4.7	5.2	5.9	6.5	7.4	8.3	9	10	11.3	12.9	14.5	16.2	18.1	20	

Distance in Miles From an FM Transmitter to Its 80-dbu (10 mv/m) Contour for Various Heights and Powers

AHAAT IN FT	POWER IN DBK																				
	-20	-18	-16	-14	-12	-10	-8	-6	-4	-2	0	2	4	6	8	10	12	14	16	18	20
3400	.3	1.8	2.1	2.6	3.2	4.0	4.8	6.0	7.3	9	12.5	5	18	20	23	26.5	30	34	38	42	46.5
3200	.3	1.8	2.1	2.6	3.2	4.0	4.8	6.0	7.3	8.8	12	15	7	19	22	25	29	32.5	36.5	40.5	45
3000	1.3	.8	2	2.6	3.2	4.0	4.8	6.0	7	8.5	11.5	14.5	7	18.5	21.5	24.5	28	31.5	35	40	43
2800	1.3	.8	2.1	2.5	3.2	4.0	4.8	5.9	7.1	8.4	11.3	14	16	18	20	23	26.5	30	34	38	41.5
2600	1.3	.8	2	2.5	3.2	4.0	4.7	5.8	7.0	8	11	13	15.5	17.5	19.6	22	25.5	29	32	35.5	40
2400	1.3	1.8	2.1	2.5	3.2	3.9	4.7	5.7	7.0	8.1	0.5	12.5	15	17	19	21.5	24.5	27.5	30.5	35	38.5
2200	.3	1.8	2.1	2.5	3.2	3.8	4.7	5.6	6.8	8	0	12	14.5	16.5	18	20	23	26.5	29.5	32.5	36.5
2000	1.3	.8	2.0	2.5	3.1	3.8	4.6	5.4	6.7	7.8	9	11.5	13.5	15	17.5	19.5	21.5	25	28	31	35
900	1.3	1.8	2.0	2.5	3.0	3.7	4.6	5.3	6.6	7.7	9		3	14.8	17	9	2	24.5	27	30	34
800	1.3	1.8	2.0	2.5	3.0	3.7	4.5	5.3	6.3	7.6	8.7	10.5	12.5	4.5	16.5	18.5	20.5	23	26	29	32.5
1700	1.3	.8	2.0	2.4	2.9	3.6	4.4	5.2	6.1	7.3	8.4	10	12	4	15.5	8	20	22	25	28	3
1600	1.2	1.7	2.0	2.3	2.9	3.6	4.3	5.1	6	7.0	8.1	9.2	11.8	13.5	15	7.5	9	21.5	24.5	27	30
1500	1.2	1.7	2.0	2.3	2.8	3.6	4.2	5.0	5.9	7.0	8.0	9.0		13	14.5	17	18.5	20.5	23	26	29
1400	1.2	.7	1.9	2.3	2.8	3.5	4.2	5.0	5.7	6.7	7.7	8.7	0.5	12	14	6	8	20	22	25	28
1300	1.2	1.7	1.9	2.2	2.7	3.4	4.1	4.8	5.6	6.4	7.4	8.3	0	11.5	13	15	.7	19	21.5	24	26.5
1200	1.2	1.7	1.8	2.2	2.7	3.3	4.0	4.7	5.4	6.2	7.1	8	9.2	11	12.5	14.5	16.5	18	20.5	23	25.5
1100	1.2	1.7	1.8	2.2	2.7	3.2	3.9	4.6	5.2	6	6.8	7.6	8.7	10.2	11.5	14	5.5	17.5	19.5	22	24.5
1000	1.2	1.6	1.8	2.2	2.6	3.1	3.8	4.4	5	5.8	6.4	7.2	8.2	9.2	11	13	15	17	18.5	20.5	23
900	1.2	.6	1.7	2.1	2.6	3	3.7	4.2	4.8	5.6	6.2	7.0	7.8	8.8	10.5	12	4	16	18	9	22
800	1.2	1.5	1.7	2.1	2.5	2.9	3.4	3.9	4.6	5	6.0	6.7	7.4	8.3	9.3	11.5	13	15	16.5	18	20
700	1.2	1.5	1.7	2.0	2.4	2.8	3.2	3.7	4.7	4.8	5.5	6.3	7.0	7.8	8.8	0	2	3.5	15.5	17	8.5
600	1.2	1.4	1.7	1.9	2.3	2.7	3.0	3.4	3.8	4.5	5.0	5.8	6.5	7.2	8	9.0	10.5	12.5	14	5.5	14.5
500	1.1	.4	1.6	1.8	2.1	2.5	2.8	3.2	3.6	4	4.6	5.2	6	6.7	7.5	8.2	9.2	11	12.5	14.5	5.5
400	1.0	1.3	1.5	1.7	2.0	2.2	2.6	2.8	3.2	3.7	4	4.7	5.2	6.0	6.7	7.5	8.2	9	11	12.5	14.5
300	.9	1.2	1.3	1.5	1.8	.9	2.2	2.6	2.8	3.2	3.6	4	4.5	5.0	5.8	6.2	7.2	7.8	8.9	10.5	12
200	.8	.0	1.2	1.3	1.5	1.7	.8	2	2.3	2.6	3.0	3.3	3.8	4.2	4.7	5.2	6.0	6.7	7.5	8.2	9.0
100	.5	.6	.8	.9	1.0	1.2	1.3	1.5	1.7	1.9	2.0	2.3	2.7	3.0	3.3	3.7	4.2	4.7	5.2	6.0	6.8

Conversion Table

MULTIPLY NUMBER OF BY ↓ TO OBTAIN NUMBER OF ↓	ANGSTROMS	MICRONS	MILS	INCHES	FEET	MILES	MILLIMETERS	CENTIMETERS	KILOMETERS
	ANGSTROMS	1	10 ⁴	2.540 × 10 ⁵	2.540 × 10 ⁸	3.048 × 10 ⁹	1.609 × 10 ¹³	10 ⁷	10 ⁸
MICRONS	10 ⁻⁴	1	2.540 × 10	2.540 × 10 ⁴	3.048 × 10 ⁵	1.609 × 10 ⁹	10 ³	10 ⁴	10 ⁹
MILS	3.937 × 10 ⁻⁶	3.937 × 10 ⁻²	1	10 ³	1.2 × 10 ⁴	6.336 × 10 ⁷	3.937 × 10	3.937 × 10 ²	3.937 × 10 ⁷
INCHES	3.937 × 10 ⁻⁹	3.937 × 10 ⁻⁵	10 ⁻³	1	12	6.336 × 10 ⁴	3.937 × 10 ⁻²	3.937 × 10 ⁻¹	3.937 × 10 ⁴
FEET	3.281 × 10 ⁻¹⁰	3.281 × 10 ⁻⁶	8.333 × 10 ⁻⁵	8.333 × 10 ⁻²	1	5.280 × 10 ³	3.281 × 10 ⁻³	3.281 × 10 ⁻²	3.281 × 10 ³
MILES	6.214 × 10 ⁻¹⁴	6.214 × 10 ⁻¹⁰	1.578 × 10 ⁻⁸	1.578 × 10 ⁻⁵	1.894 × 10 ⁻⁴	1	6.214 × 10 ⁻⁷	6.214 × 10 ⁻⁶	6.214 × 10 ⁻¹¹
MILLIMETERS	10 ⁻⁷	10 ⁻³	2.540 × 10 ⁻²	2.540 × 10	3.048 × 10 ⁷	1.609 × 10 ⁶	1	10	10 ⁶
CENTIMETERS	10 ⁻⁸	10 ⁻⁴	2.540 × 10 ⁻³	2.540	3.048 × 10	1.609 × 10 ⁵	0.1	1	10 ⁵
KILOMETERS	10 ⁻¹³	10 ⁻⁹	2.540 × 10 ⁻⁸	2.540 × 10 ⁻⁵	3.048 × 10 ⁻⁴	1.609	10 ⁻⁶	10 ⁻⁵	1
° CENTIGRADE	C = 5/9 (F - 32)								
° FAHRENHEIT	F = 9/5 C + 32								

DECIBELS ABOVE AND BELOW REFERENCE LEVEL 1mw INTO 600 OHMS

Voltage applies to 600 ohm circuits only. Power applies to any impedance.

dB DOWN		LEVEL dBm	dB UP	
VOLTS	MILLIWATTS		VOLTS	MILLIWATTS
0.774 6	1.000	0+	0.774 6	1.000
0.690 5	0.794 3	1	0.869 1	1.259
0.616 7	0.631 0	2	0.975 2	1.585
0.548 4	0.501 2	3	1.094	1.995
0.488 7	0.398 1	4	1.228	2.512
0.435 6	0.316 2	5	1.377	3.162
0.388 2	0.251 2	6	1.546	3.981
0.346 0	0.199 5	7	1.734	5.012
0.308 4	0.158 5	8	1.946	6.310
0.274 8	0.125 9	9	2.183	7.943
0.244 9	0.100 0	10	2.449	10.000
0.218 3	0.079 43	11	2.748	12.59
0.194 6	0.063 10	12	3.084	15.85
0.173 4	0.050 12	13	3.460	19.95
0.154 6	0.039 81	14	3.882	25.12
0.137 7	0.031 62	15	4.356	31.62
0.122 8	0.025 12	16	4.887	39.81
0.109 4	0.019 95	17	5.484	50.12
0.097 52	0.015 85	18	6.153	63.10
0.086 91	0.012 59	19	6.905	79.43
0.077 46	0.010 00	20	7.746	100.00
0.043 56	0.003 16	25	13.77	316.2
0.024 49	0.001 00	30	24.49	1.000 Watt
0.013 77	0.000 316	35	43.56	3.162 Watts
0.007 746	0.000 100	40	77.46	10.00 Watts
0.004 356	3.16×10^{-5}	45	137.7	31.62 Watts
0.002 449	1.00×10^{-5}	50	244.9	100 Watts
0.001 377	3.16×10^{-6}	55	435.6	316.2 Watts
0.000 774 6	1.00×10^{-6}	60	774.6	1 000 Watts
0.000 435 6	3.16×10^{-7}	65	1 377	3 162 Watts
0.000 244 9	1.00×10^{-7}	70	2 449	10 000 Watts
0.000 137 7	3.16×10^{-8}	75	4 356	31 620 Watts
0.111 077 46	1.00×10^{-8}	80+	7 746	100 000 Watts

USE OF TABLE

Table is tabulated in one dB steps from 0 dBm to ± 20 dBm; thereafter in five dB steps to ± 80 dBm. However, the table may be used in one dB steps to ± 80 dBm by noting that, except for decimal locations, the power levels repeat themselves every ± 10 dB and the voltage levels repeat every ± 20 dB.

Example 1. What is the voltage produced by a level of -56 dBm on 600 ohms? Subtract 40 from 56, giving 16. Enter table at 16 dBm, read volts column on left as 0.1228 volts. Now enter table at 55 and 60 dBm; -56 dBm is between these two levels, so table shows correct answer as 0.001228 volts.

Example 2. What is the voltage produced by a level of -68 dBm on 600 ohms? Subtract 60 from 68, giving 8. Enter table at 8 dBm, read volts column on left as 0.3084 volts.

Now enter table at 65 and 70 dBm; -68 dBm is between these two levels, so the table shows correct answer as 0.0003084 volts.

Example 3. What is the voltage produced by a level of +33 dBm on 600 ohms? Subtract 20 from 33, giving 13. Enter the table at 13 dBm, read volts column at right as 3.460 volts. Now enter table at 30 and 35 dBm; +33 dBm is between these two levels, so the table shows the correct answer as 34.6 volts.

Frequency Designation of FM Broadcast Channels

FREQ (MHz)	CHANNEL NO.	FREQ (MHz)	CHANNEL NO.	FREQ (MHz)	CHANNEL NO.
88.1	.201	94.9	.235	101.5	.268
88.3	.202	95.1	.236	101.7	.269
88.5	.203	95.3	.237	101.9	.270
88.7	.204	95.5	.238	102.1	.271
88.9	.205	95.7	.239	102.3	.272
89.1	.206	95.9	.240	102.5	.273
89.3	.207	96.1	.241	102.7	.274
89.5	.208	96.3	.242	102.9	.275
89.7	.209	96.5	.243	103.1	.276
89.9	.210	96.7	.244	103.3	.277
90.1	.211	96.9	.245	103.5	.278
90.3	.212	97.1	.246	103.7	.279
90.5	.213	97.3	.247	103.9	.280
90.7	.214	97.5	.248	104.1	.281
90.9	.215	97.7	.249	104.3	.282
91.1	.216	97.9	.250	104.5	.283
91.3	.217	98.1	.251	104.7	.284
91.5	.218	98.3	.252	104.9	.285
91.7	.219	98.5	.253	105.1	.286
91.9	.220	98.7	.254	105.3	.287
92.1	.221	98.9	.255	105.5	.288
92.3	.222	99.1	.256	105.7	.289
92.5	.223	99.3	.257	105.9	.290
92.7	.224	99.5	.258	106.1	.291
92.9	.225	99.7	.259	106.3	.292
93.1	.226	99.9	.260	106.5	.293
93.3	.227	100.1	.261	106.7	.294
93.5	.228	100.3	.262	106.9	.295
93.7	.229	100.5	.263	107.1	.296
93.9	.230	100.7	.264	107.3	.297
94.1	.231	100.9	.265	107.5	.298
94.3	.232	101.1	.266	107.7	.299
94.5	.233	101.3	.267	107.9	.300
94.7	.234				

Channels Available for Assignment to Noncommercial Educational FM Stations

FREQ (MHz)	CHANNEL NO.	FREQ (MHz)	CHANNEL NO.	FREQ (MHz)	CHANNEL NO.
88.1	.201	89.5	.208	90.9	.215
88.3	.202	89.7	.209	91.1	.216
88.5	.203	89.9	.210	91.3	.217
88.7	.204	90.1	.211	91.5	.218
88.9	.205	90.3	.212	91.7	.219
89.1*	.206	90.5	.213	91.9	.220
89.3	.207	90.7	.214		

*The frequency 89.1 MHz in the New York City metropolitan area is reserved for the use of the United Nations.

Convenient Tables for . . .

1. Converting Wire Gage to Inches of Diameter and Circular Mil Area and
 2. Selecting Proper Size A-MP Terminals or Connectors Use to Convert Wire Gage to Inches of Diameter, CMA and mm²
- To read mils direct, move decimal point three places to the right.

AWG	DIA INCHES	CMA	AWG	DIA INCHES	CMA
4/0	0.460	212,000	19	0.36	1,290
3/0	0.410	168,000	20	0.032	1,020
2/0	0.365	133,000	21	0.0285	810
1/0	0.325	106,000	22	0.0253	642
1	0.289	83,700	23	0.0226	509
2	0.258	66,400	24	0.0201	404
3	0.229	52,600	25	0.0179	320
4	0.204	41,700	26	0.0159	254
5	0.182	33,100	27	0.0142	202
6	0.162	26,300	28	0.0126	160
7	0.144	20,800	29	0.0113	127
8	0.128	16,500	30	0.0100	101
9	0.114	13,100	31	0.0089	79.7
10	0.102	10,400	32	0.0080	63.2
11	0.091	8,230	33	0.0071	50.1
12	0.081	6,530	34	0.0063	39.8
13	0.072	5,180	35	0.0056	31.5
14	0.064	4,110	36	0.0050	25.0
15	0.057	3,260	37	0.0045	19.8
16	0.051	2,580	38	0.0040	15.7
17	0.045	2,050	39	0.0035	12.5
18	0.040	1,620	40	0.0031	9.9

Conversion Table AWG-CMA to Metric Wire Range

AWG	CMA	mm ²
26-22	202-810	0.10-0.41
24-20	475-1,200	0.24-0.60
22-16	509-3,260	0.25-1.65
22-14	509-5,180	0.25-2.62
20-16HD	810-3,260	0.41-1.65
16-14	2,050-5,180	1.03-2.62
16-14HD	2,050-5,180	1.03-2.62
14-12	3,260-8,230	1.65-4.16
12-10	5,180-13,100	2.62-6.63
12-10HD	5,180-13,100	2.62-6.63
8	13,100-20,800	6.63-10.53
6	20,800-33,100	10.53-16.76
4	33,100-52,600	16.76-26.64
4HD	33,100-52,600	16.76-26.64
2	52,600-83,700	26.64-42.40
1/0	83,700-119,500	42.40-60.53
2/0	119,500-150,500	60.53-76.24
3/0	150,500-190,000	76.24-96.25
4/0	190,000-231,000	96.25-117.02

To Calculate the diameter of a wire in mm² use following formula

S = Diameter of wire in mm²

d = Diameter of one strand in mm · S = $\pi \frac{d^2}{4} \times 4$

$\pi = 3.14$ n = number of strands

Forward VS Reflected Power

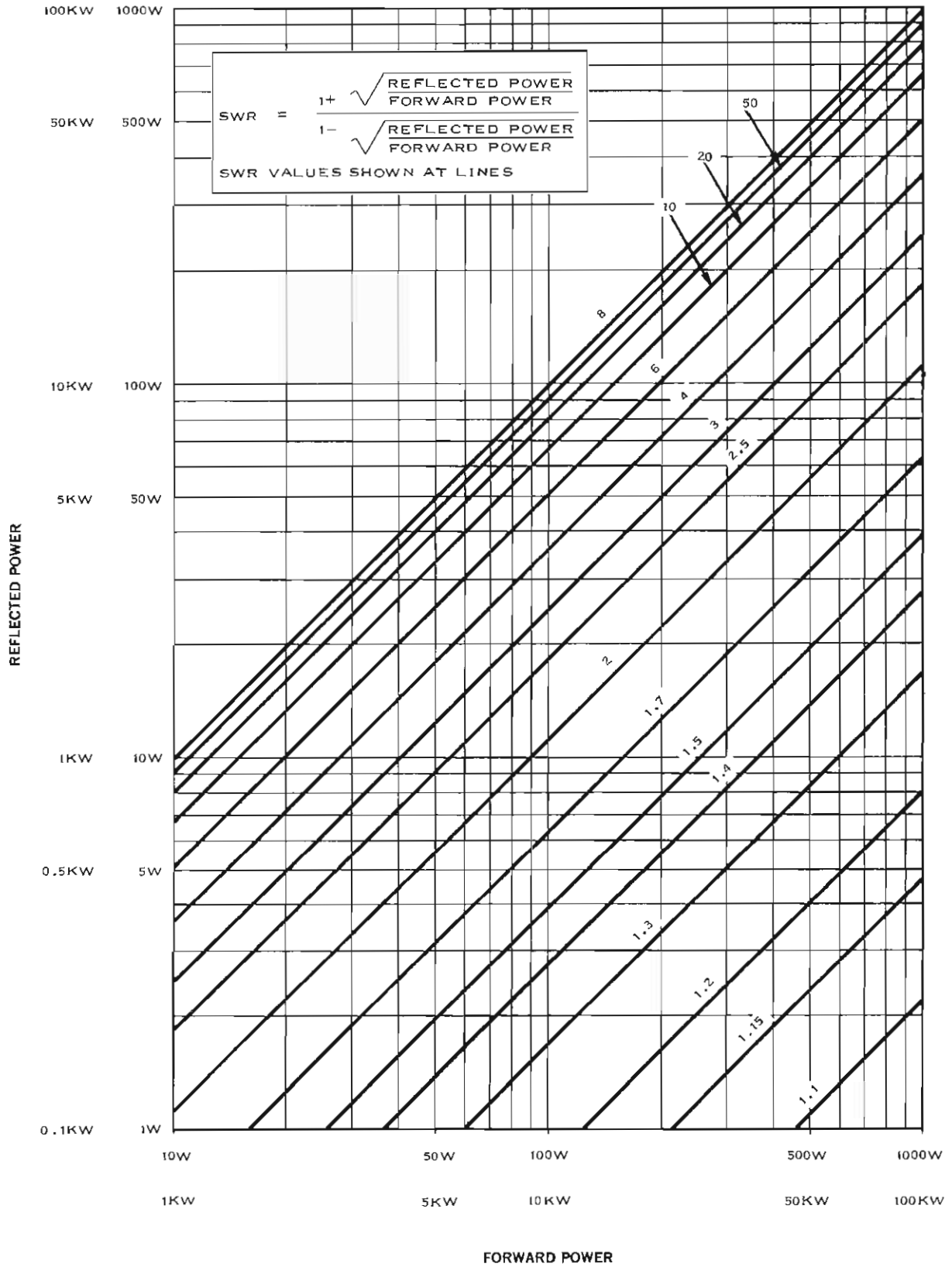

Attenuation Expressed as Efficiency

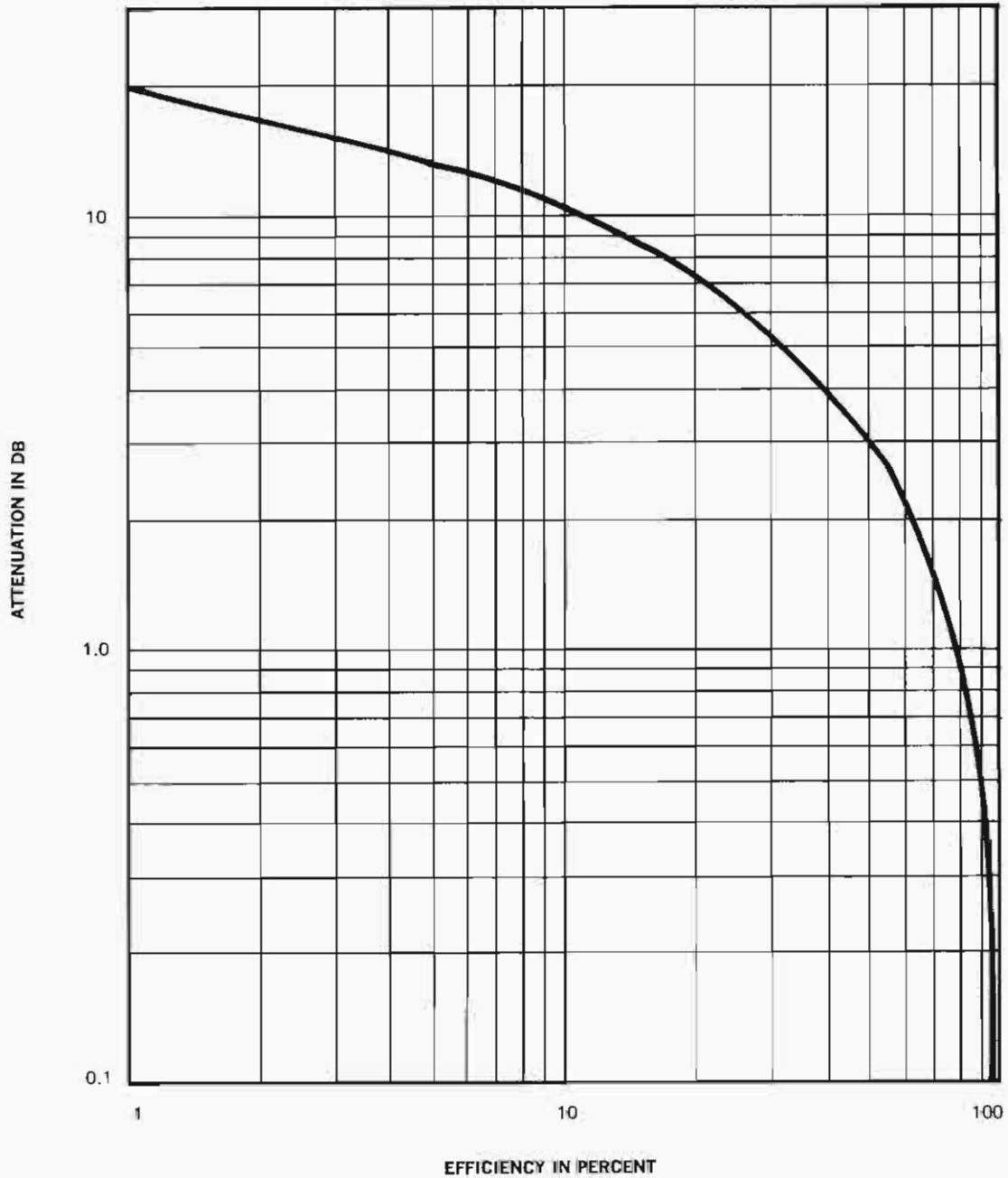

To obtain total loss in a given transmission line, multiply the attenuation in db per 100 ft by the number of 100-foot lengths of line to be used. By referring to the curve on this page, the overall transmission efficiency may be determined.

Audio Dividing Pads

PART NO	CIRCUIT	NO OUTPUTS	DB LOSS	INPUT	OUTPUT	RESISTOR EACH
1	BAL	2	5.0			100Ω
2	BAL	3	0.5			150Ω
3	BAL	4	12.0			180Ω
4	BAL	5	14.0			200Ω
5	BAL	6	15.6			214Ω
6	BAL	8	13.1			235Ω
7	UNBAL	2	6.0			200Ω
8	UNBAL	3	9.5			300Ω
9	UNBAL	4	12.0			360Ω
10	UNBAL	5	14.0			400Ω
11	UNBAL	6	15.6			428Ω
12	UNBAL	8	18.1			466Ω
13	BAL	10	20.0			245Ω

Attenuator Network

Impedance Loss, dB	600 Ohms		600 Ohms		600 Ohms		600 Ohms		600 Ohms		600 Ohms	
	R ₁ Ohms	R ₂ Ohms	R ₁ Ohms	R ₂ Ohms	R ₁ Ohms	R ₂ Ohms	R ₁ Ohms	R ₂ Ohms	R ₁ Ohms	R ₂ Ohms	R ₁ Ohms	R ₂ Ohms
0	0	∞	0	∞	0	∞	0	∞	0	∞	0	∞
0.1	3.58	50204	3.58	100500	3.58	100500	3.58	100500	3.58	100500	3.58	100500
0.2	6.82	26280	6.82	57380	6.82	57380	6.82	57380	6.82	57380	6.82	57380
0.3	10.32	17460	10.32	34900	10.32	34900	10.32	34900	10.32	34900	10.32	34900
0.4	13.79	13068	13.79	26100	13.79	26100	13.79	26100	13.79	26100	13.79	26100
0.5	17.20	10464	17.20	20920	17.20	20920	17.20	20920	17.20	20920	17.20	20920
0.6	20.9	8640	20.9	17230	20.9	17230	20.9	17230	20.9	17230	20.9	17230
0.7	24.2	7428	24.2	14880	24.2	14880	24.2	14880	24.2	14880	24.2	14880
0.8	27.5	6540	27.5	13100	27.5	13100	27.5	13100	27.5	13100	27.5	13100
0.9	31.02	5787	31.02	11600	31.02	11600	31.02	11600	31.02	11600	31.02	11600
1.0	34.5	5208	34.5	10440	34.5	10440	34.5	10440	34.5	10440	34.5	10440
1.5	51.8	3452	51.8	6950	51.8	6950	51.8	6950	51.8	6950	51.8	6950
2.0	68.8	2582	68.8	5232	68.8	5232	68.8	5232	68.8	5232	68.8	5232
2.5	85.9	2053	85.9	4195	85.9	4195	85.9	4195	85.9	4195	85.9	4195
3.0	102.7	1703	102.7	3505	102.7	3505	102.7	3505	102.7	3505	102.7	3505
3.5	119.2	1448	119.2	3021	119.2	3021	119.2	3021	119.2	3021	119.2	3021
4.0	135.8	1249	135.8	2651	135.8	2651	135.8	2651	135.8	2651	135.8	2651
4.5	152.2	1109	152.2	2365	152.2	2365	152.2	2365	152.2	2365	152.2	2365
5.0	168.1	987.6	168.1	2141	168.1	2141	168.1	2141	168.1	2141	168.1	2141
5.5	184.0	886.8	184.0	1956	184.0	1956	184.0	1956	184.0	1956	184.0	1956
6.0	199.3	803.4	199.3	1807	199.3	1807	199.3	1807	199.3	1807	199.3	1807
6.5	214.6	730.8	214.6	1679	214.6	1679	214.6	1679	214.6	1679	214.6	1679
7.0	229.7	685.2	229.7	1569	229.7	1569	229.7	1569	229.7	1569	229.7	1569
7.5	244.2	615.6	244.2	1475	244.2	1475	244.2	1475	244.2	1475	244.2	1475
8.0	258.4	567.6	258.4	1393	258.4	1393	258.4	1393	258.4	1393	258.4	1393
8.5	272.3	525.0	272.3	1322	272.3	1322	272.3	1322	272.3	1322	272.3	1322
9.0	285.8	487.2	285.8	1260	285.8	1260	285.8	1260	285.8	1260	285.8	1260
9.5	298.9	453.0	298.9	1204	298.9	1204	298.9	1204	298.9	1204	298.9	1204
10.0	312.0	421.6	312.0	1154	312.0	1154	312.0	1154	312.0	1154	312.0	1154
11.0	336.1	367.4	336.1	1071	336.1	1071	336.1	1071	336.1	1071	336.1	1071
12.0	359.1	321.7	359.1	1002	359.1	1002	359.1	1002	359.1	1002	359.1	1002
13.0	380.5	282.8	380.5	946.1	380.5	946.1	380.5	946.1	380.5	946.1	380.5	946.1
14.0	400.4	249.4	400.4	899.1	400.4	899.1	400.4	899.1	400.4	899.1	400.4	899.1
15.0	418.8	220.4	418.8	859.6	418.8	859.6	418.8	859.6	418.8	859.6	418.8	859.6
16.0	435.8	195.1	435.8	826.0	435.8	826.0	435.8	826.0	435.8	826.0	435.8	826.0
17.0	451.5	172.9	451.5	797.3	451.5	797.3	451.5	797.3	451.5	797.3	451.5	797.3
18.0	465.8	152.5	465.8	772.8	465.8	772.8	465.8	772.8	465.8	772.8	465.8	772.8
19.0	479.0	136.4	479.0	751.7	479.0	751.7	479.0	751.7	479.0	751.7	479.0	751.7
20.0	490.4	121.2	490.4	733.3	490.4	733.3	490.4	733.3	490.4	733.3	490.4	733.3
22.0	511.7	95.9	511.7	703.6	511.7	703.6	511.7	703.6	511.7	703.6	511.7	703.6
24.0	528.8	76.0	528.8	680.8	528.8	680.8	528.8	680.8	528.8	680.8	528.8	680.8
26.0	542.7	60.3	542.7	663.4	542.7	663.4	542.7	663.4	542.7	663.4	542.7	663.4
28.0	554.1	47.8	554.1	649.7	554.1	649.7	554.1	649.7	554.1	649.7	554.1	649.7
30.0	563.0	37.99	563.0	639.2	563.0	639.2	563.0	639.2	563.0	639.2	563.0	639.2
32.0	570.6	30.16	570.6	630.9	570.6	630.9	570.6	630.9	570.6	630.9	570.6	630.9
34.0	576.5	288.3	576.5	624.4	576.5	624.4	576.5	624.4	576.5	624.4	576.5	624.4
36.0	581.1	18.98	581.1	619.3	581.1	619.3	581.1	619.3	581.1	619.3	581.1	619.3
38.0	585.1	15.11	585.1	615.3	585.1	615.3	585.1	615.3	585.1	615.3	585.1	615.3
40.0	588.1	12.00	588.1	612.1	588.1	612.1	588.1	612.1	588.1	612.1	588.1	612.1

Reactance Chart

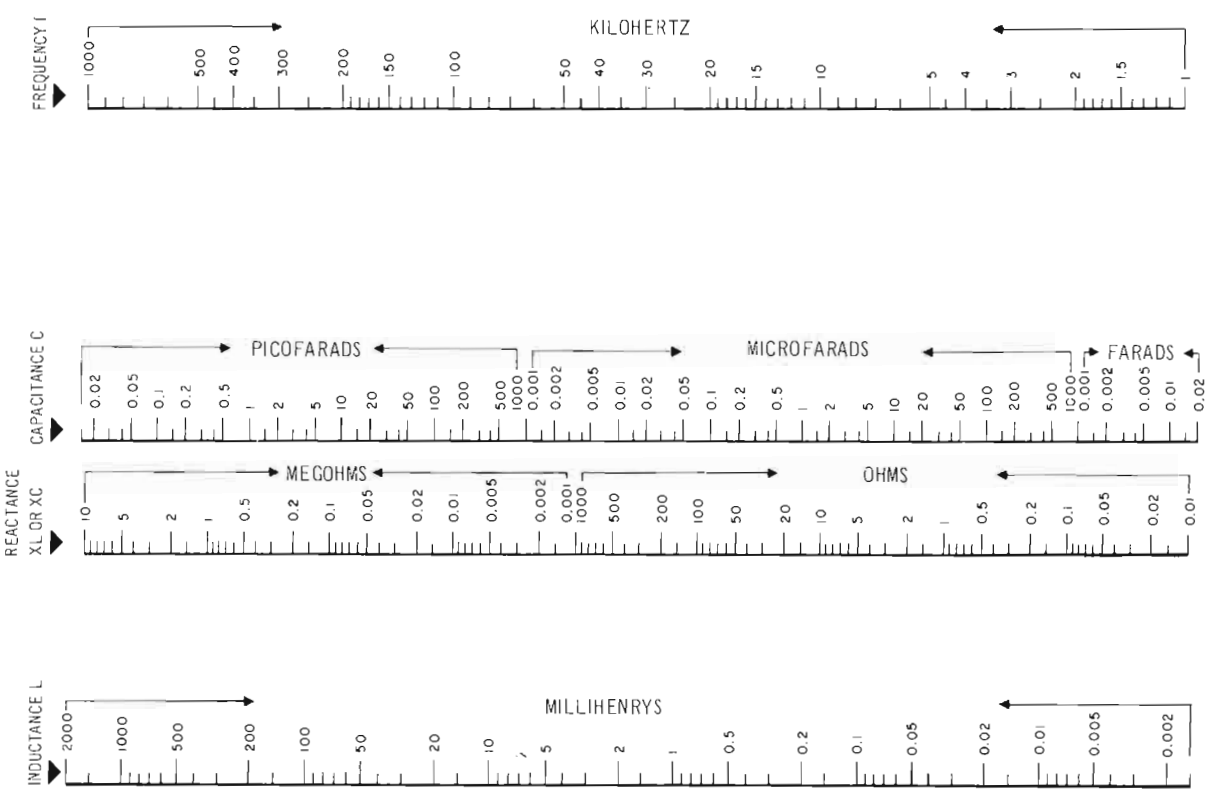
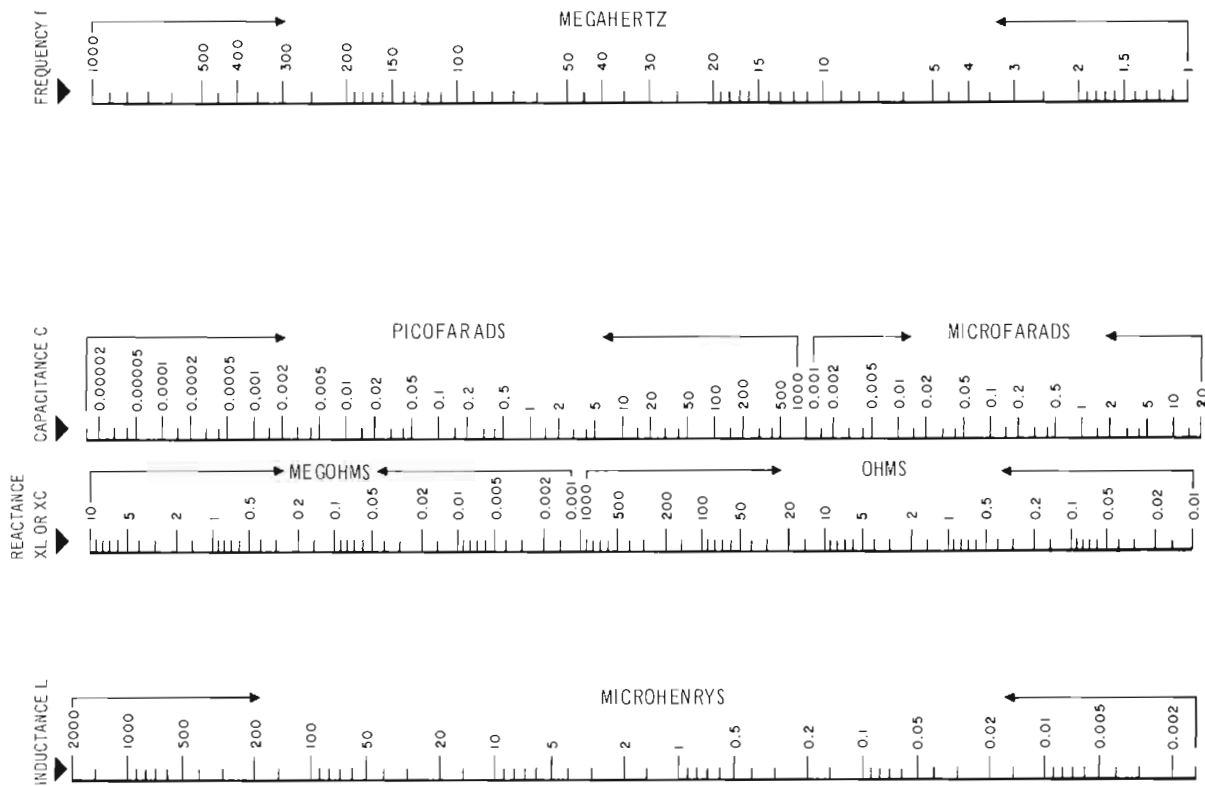

Volume Level to Power and Voltage Conversion

REFERENCE LEVEL: 0 DBM = 1 MW, 600 OHMS					
MILLIWATTS	VOLTS	DBM	WATTS	VOLTS	DBM
0.000001	0.0007746	- 60	0.001000	0.7746	0
0.000010	0.002449	- 50	0.002512	1.228	+ 4
0.000100	0.007746	- 40	0.006310	1.946	+ 8
0.001	0.02449	- 30	0.01000	2.449	+ 10
0.010	0.07746	- 20	0.1000	7.746	+ 20
0.100	0.2449	- 10	1.000	24.49	+ 30
1.000	0.7746	0	10.00	77.46	+ 40

Decibels VS Ratio

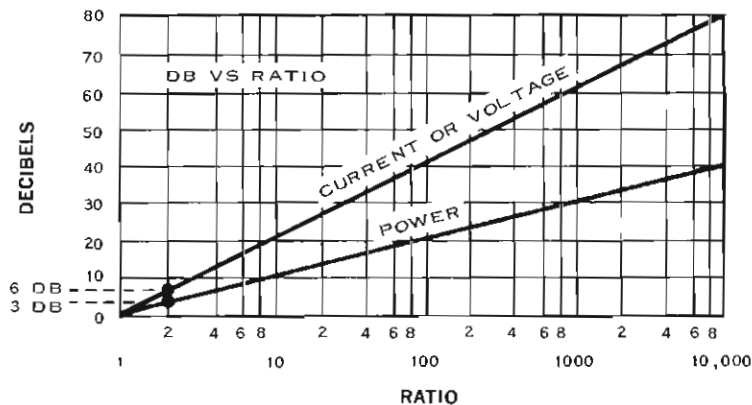

Increase in Attenuation in Line Due to VSWR on Line

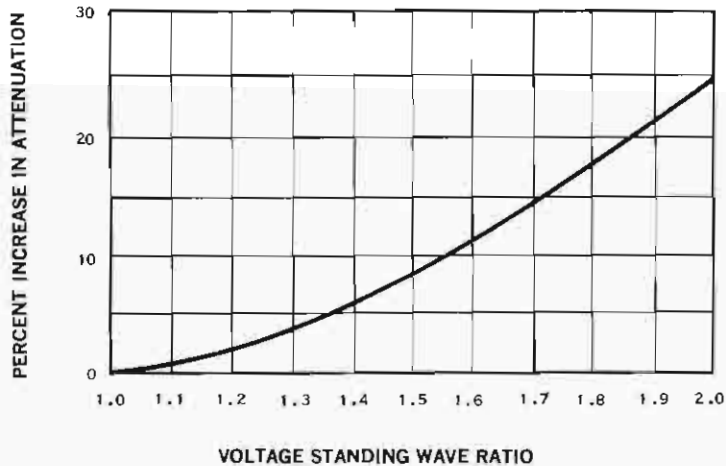

Standard Color Codes — Resistors and Capacitors

INSULATED UNINSULATED COLOR	FIRST RING BODY COLOR FIRST FIGURE	SECOND RING END COLOR SECOND FIGURE	THIRD RING DOT COLOR MULTIPLIER
BLACK	0	0	NONE
BROWN	1	1	0
RED	2	2	00
ORANGE	3	3	.000
YELLOW	4	4	0.000
GREEN	5	5	00.000
BLUE	6	6	.000.000
VIOLET	7	7	0.000.000
GRAY	8	8	00.000.000
WHITE	9	9	000.000.000

JAN 8,
1948
RMA
CODE

MOLDED MICA TYPE CAPACITORS

CURRENT STANDARD CODE

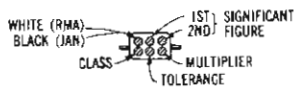

RMA 3-DOT (OBSOLETE) RATED 500 WVDC ±20% TOL.



BUTTON SILVER MICA CAPACITOR

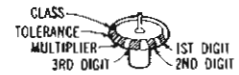

RMA (5-DOT OBSOLETE CODE)

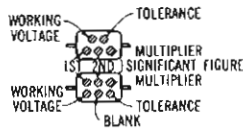
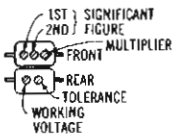

RMA 4-DOT (OBSOLETE)

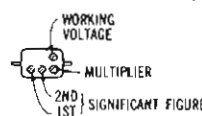

RMA 6-DOT (OBSOLETE)

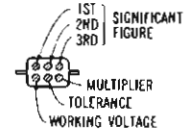

MOLDED PAPER TYPE CAPACITORS

TUBULAR CAPACITOR

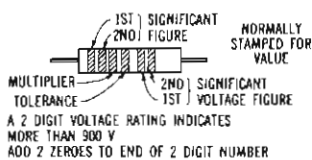

MOLDED FLAT CAPACITOR COMMERCIAL CODE

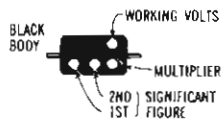

JAN. CODE CAPACITOR

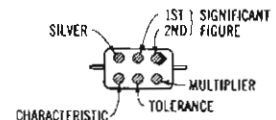

CERAMIC CAPACITORS

5-DOT RADIAL LEAD CERAMIC CAPACITOR



EXTENDED RANGE TC CERAMIC HICAP

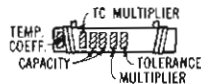

AXIAL LEAD CERAMIC CAPACITOR

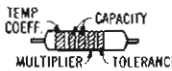

DISC CERAMIC RMA CODE



BY-PASS COUPLING CERAMIC CAPACITOR

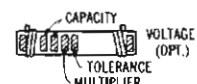

RESISTORS

RADIAL LEAD DOT RESISTOR

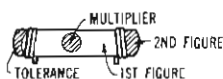

RADIAL LEAD (BAND) RESISTOR

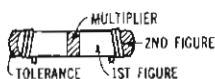

AXIAL LEAD RESISTOR

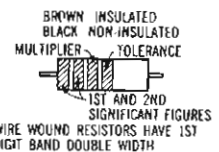

Station Layouts

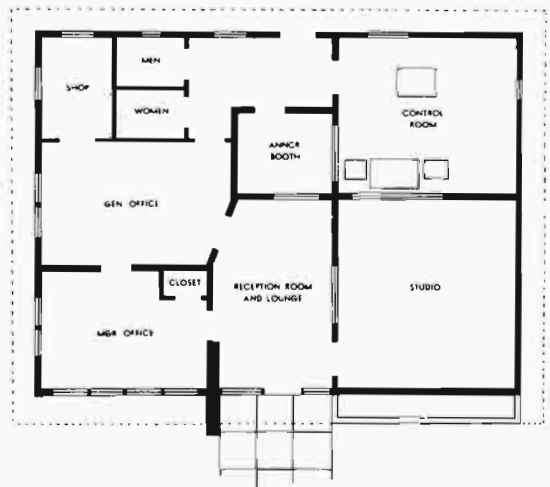
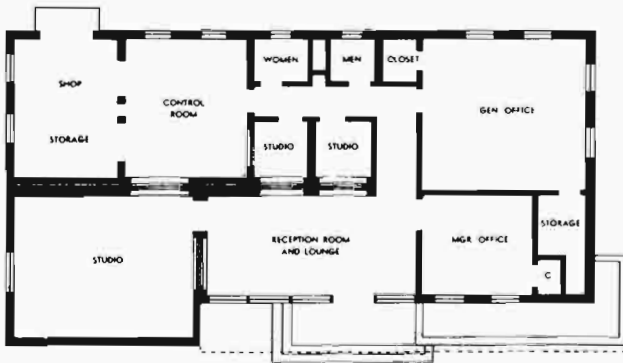
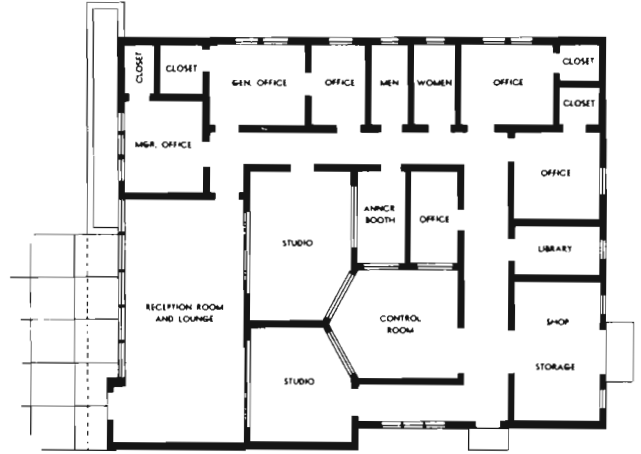
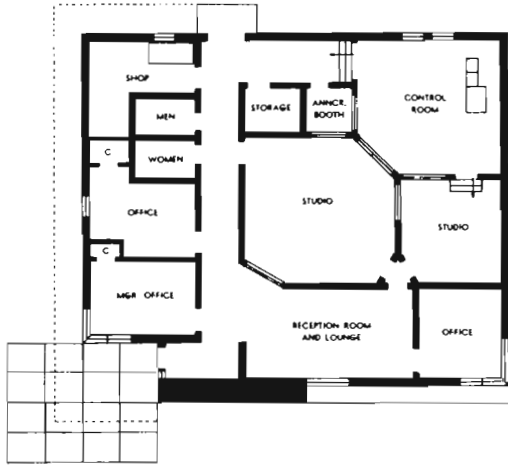

COLLINS BROADCAST SALES POLICY

How to Order

This catalog has been prepared to make it possible for you to order directly from Collins Broadcast Marketing or your Collins Broadcast Sales Engineer with a minimum of effort and maximum assurance that you will receive the best equipment available. Collins type numbers and part numbers are listed so that you may order by mail, if you wish, and receive the same fast, personal service that is available from your Collins Broadcast Sales Engineer.

Prices

Prices in the price book replace all previous prices and are subject to change without notice. Orders are filled at prices in effect at the time of shipment. If prices are reduced, you receive the advantage of the lower price. Collins customers outside the 50 United States should contact Collins Radio Company, International Division, Dallas, Texas, or Collins Radio Company of Canada, Ltd., Toronto M4A 1C7, Ontario.

Signed Orders

All orders must be signed by an officer of the purchasing corporation, partnership, or company. All orders, down payment agreements and terms are subject to final acceptance at the Collins Broadcast Marketing office in Dallas, Texas.

Substitution and Modification

Collins reserves the right to modify, without notice, the design and specifications of equipment designed by Collins.

Terms of Sale

Terms of payment for all Collins Radio Company broadcast equipment sales fall into the following categories:

1. Cash in advance or COD
2. Net 30 days
3. Conditional Sales Contract

Down Payment

On all firm orders applicable to Conditional Sales Contracts, a minimum down payment of 25 percent is required, with the balance spread equally. In the case of contingent orders, a minimum of \$1000.00 or 5% whichever is greater.

Shipment

In the absence of specific instructions, Collins will select the carrier to whom delivery will be made for shipment to the purchaser.

Damages in Shipping

Usually, shipments from Collins Radio Company or one of its vendors on a drop ship basis are made "Shipping Charges Collect". As such, the equipment automatically becomes the property of the purchaser when picked up by the carrier. Should damage occur during shipment, the request for inspection and claims for damage must be made by the purchaser with reimbursement paid directly to him. Collins will gladly assist the purchaser with any necessary information he may require to successfully negotiate a claim.

Delivery

Unless otherwise specified, delivery will be made fob from one of Collins various shipping points or from the shipping point of a supplier of Collins. Although Collins makes every effort to expedite shipments, the Company cannot guarantee nor be held responsible for delays in shipments caused by a supplier of Collins or by the carrier.

Field Service

Fast field service is assured owners of Collins broadcast equipment by the Collins Service Division. A staff of selected specialists is maintained to provide Collins customers a level of service consistent with high performance equipment. For service on Collins equipment, which is essential to continued on-the-air operation of the station, contact your Collins Broadcast Sales Engineer. For emergency, after-hours service, Call Dallas, Texas, 214 AD 5-9511. Collins field service engineers are stationed at key points throughout the world. Overseas customers contact your nearest International office.

Returning Goods

All returned goods, whether for repair, replacement, or credit, must be authorized by Collins Radio Company. A return material tag and service report will be enclosed with your authorization for the return of the goods. An accurately completed report will assure prompt handling of repairs, necessary parts, replacements, and adjustments of accounts where required. Address material as follows:

Collins Radio Company
Dallas, Texas 75207

Attention: CRG/Re (Sales Order Number)

Contingent on Collins agreement to accept such returned goods, a restocking charge will be made on all items returned due to customer requested changes or deletions from original orders after shipment is made. All returns must be sent prepaid and properly insured by the customer. If warranted, Collins will adjust issue credit for these shipping expenses.

WARRANTY AND GUARANTY

(a) Collins warrants that each equipment of Collins manufacture or Collins design sold hereunder will, at the date of its delivery, meet its published specification and will be free from defects in design, workmanship and material.

(b) Collins agrees to repair or replace any equipment of its manufacture or of its design which fails to meet the warranty set forth in subparagraph (a) above, or, at Collins' option, to refund the purchase price of such equipment, provided:

(1) Notice of the failure of such equipment to meet its warranted condition is given in writing to Collins within two (2) years from the date of delivery of such equipment, with the exception of tape heads and rotating machinery such as blowers, motors and fans, for which notice must be given in writing to Collins within one (1) year from the date of delivery; and

(2) The equipment is returned to Collins in accordance with Collins instructions; and

(3) The failure of the equipment to meet its warranted condition is not caused by abuse or improper use, maintenance, repair or alteration by any person or organization other than Collins or Collins' Service Center.

(c) Any equipment or goods sold hereunder which is not of Collins manufacture or of Collins design is sold subject only to the warranty or guaranty of the suppliers

thereof. The buyer shall only receive such adjustment as Collins may obtain from the suppliers thereof.

(d) The agreement of this paragraph does not extend to tubes, lamps, fuses and other expendable items which are normally replaced upon their failure as a part of routine maintenance.

(e) The buyer acknowledges that he has read and is familiar with the published specifications for the equipment and goods sold hereunder and, relying upon his own judgment or the judgment of a consultant hired by him, has satisfied himself that the equipment is fit for buyer's intended purpose.

(f) In the event a warranty implied by law is, or becomes applicable to the equipment sold hereunder, buyer's sole right and remedy against Collins for breach of the implied warranty shall be limited to the refund of the purchase price, repair, or replacement of the equipment provided the breach of such implied warranty and notice thereof occur within one (1) year from the date of delivery of such equipment.

(g) The remedies set forth in this paragraph are exclusive and constitute buyer's sole right and remedy under this agreement. In no event shall Collins have any liability for consequential damages or for loss, damage or expense directly or indirectly arising from the use of the equipment sold hereunder, or any inability to use them separately or in combination with other equipment or material, or from any other cause.

COLLINS RADIO COMPANY

Dallas, Texas 75207

(214) 235-9511